

Panasonic®

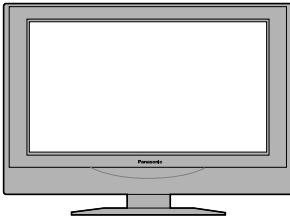

LCD TV Operating Instructions

Model No. **TC-22LH1**



<p>For assistance, please call : 1-800-211-PANA (7262) or send e-mail to : consumerproducts@panasonic.com or visit us at www.panasonic.com (U.S.A)</p>
<p>For assistance, please call : 787-750-4300 or visit us at www.panasonic.com (Puerto Rico)</p>
<p>For assistance, please call : 1-800-561-5505 or visit us at www.panasonic.ca (Canada)</p>

Before connecting, operating or adjusting this product, please read these instructions completely.
Please keep this manual for future reference.

English

TQBC0633-1

Important Safety Instructions



The lightning flash with arrow head within a triangle is intended to tell the user that parts inside the product are a risk of electric shock to persons.



The exclamation point within a triangle is intended to tell the user that important operating and servicing instructions are in the papers with the appliance.

■ **Note to CATV System Installer:** This reminder is provided to direct the CATV system installer's attention to Article 820–40 of the NEC that provides guidelines for proper grounding and, in particular, specifies that the cable ground shall be connected to the grounding system of the building, as close to the point of cable entry as practical.

■ Important Safety Instructions for LCD TV

- 1) Read these instructions.
All the safety and operating instructions should be read before the appliance is operated.
- 2) Keep these instructions.
The safety and operating instructions should be retained for future reference.
- 3) Heed all warnings.
All warnings on the appliance and in the operating instructions should be adhered to.
- 4) Follow all instructions.
All operating and use instructions should be followed.
- 5) Do not use this apparatus near water.
For example, near a bathtub, wash bowl, kitchen sink, or laundry tub, in a wet basement, or near a swimming pool, and the like.
- 6) Clean only with dry cloth.
Do not use liquid cleaners or aerosol cleaners. Use a dry cloth for cleaning.
- 7) Do not block any ventilation openings. Install in accordance with the manufacturer's instructions.
Slots and Openings in the cabinet are provided for ventilation and to ensure reliable operation of the product and to protect it from overheating. The openings should never be blocked by placing the product on a bed, sofa, rug, or other similar surface.
- 8) Do not install near any heat sources such as radiators, heat registers, stoves, or other apparatus (including amplifiers) that produce heat.
This product should not be placed in a built-in installation such as a bookcase or rack unless proper ventilation is provided or the manufacturer's instructions have been adhered to.
- 9) Protect the power cord from being walked on or pinched particularly at plugs, convenience receptacles, and the point where they exit from the apparatus.
- 10) Only use attachments / accessories specified by the Manufacturer.
- 11) Use only with the cart, stand, tripod, bracket, or table specified by the manufacturer, or sold with the apparatus. When a cart is used, use caution when moving the cart / apparatus combination to avoid injury from tip-over.
Quick stops, excessive force, and uneven surfaces may cause the appliance and cart combination to overturn.
- 12) Unplug this apparatus during lightning storms or when unused for long periods of time.
This will prevent damage to the product due to lightning and power-line surges.
- 13) Refer all servicing to qualified service personnel. Servicing is required when the apparatus has been damaged in any way, such as power-supply cord or plug is damaged, liquid has been spilled or objects have fallen into the apparatus, the apparatus has been exposed to rain or moisture, does not operate normally, or has been dropped.
- 14) To prevent electric shock, ensure the grounding pin on the AC cord power plug is securely connected.



Important Safety Instructions

15) If an outside antenna is connected to the television equipment, be sure the antenna system is grounded so as to provide some protection against voltage surges and built up static charges. In the U.S. Selection 810-21 of the National Electrical Code provides information with respect to proper grounding of the mast and supporting structure, grounding of the lead-in wire to an antenna discharge unit, size of grounding conductors, location of antenna discharge unit, connection to grounding electrodes, and requirements for the grounding electrode.

16) An outside antenna system should not be located in the vicinity of overhead power lines or other electric light or power circuits, or where it can fall into such power lines or circuits. When installing an outside antenna system extreme care should be taken to keep from touching such power lines or circuits as contact with them might be fatal.

17) Unplug this LCD TV from the wall outlet, and refer servicing to qualified service personnel under the following conditions:

- When the power cord or plug is damaged or frayed.
- If liquid has been spilled into the LCD TV.
- If the LCD TV has been exposed to rain or water.
- If the LCD TV does not operate normally by following the operating instructions.

Adjust only those controls that are covered by the operating instructions as improper adjustment of other controls may result in damage and will often require extensive work by a qualified technician to restore the LCD TV to normal operation.

- If the LCD TV has been dropped or the cabinet has been damaged.
 - When the LCD TV exhibits a distinct change in performance - this indicates a need for service.
- 18) When replacement parts are required, be sure the service technician uses replacement parts specified by the manufacturer that have the same characteristics as the original part. Unauthorized substitutions may result in fire, electric shock, or other hazards.

19) **WARNING: TO REDUCE THE RISK OF FIRE OR ELECTRIC SHOCK, DO NOT EXPOSE THIS APPARATUS TO RAIN OR MOISTURE.**

DO NOT PLACE LIQUID CONTAINERS (FLOWER VASES, CUPS, COSMETICS, ETC.) ABOVE THE SET. (INCLUDING ON SHELVES ABOVE, ETC.)

20) **CAUTION: TO PREVENT ELECTRIC SHOCK DO NOT USE THIS PLUG WITH A RECEPTACLE OR OTHER OUTLET UNLESS THE BLADES CAN BE FULLY INSERTED TO PREVENT BLADE EXPOSURE.**

EXAMPLE OF ANTENNA GROUNDING AS PER (NEC) NATIONAL ELECTRICAL CODE

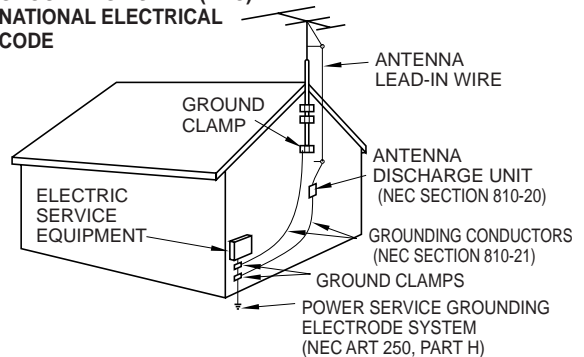

NOTE: ● This equipment is designed to operate in the U.S.A. and other countries where the broadcasting system and AC house current is exactly the same as in the U.S.A.

- The marking or retained image on the LCD panel resulting from fixed image use is not an operating defect and as such is not covered by Warranty. This product is not designed to display fixed image patterns for extended periods of time.

■ Important Information Regarding Use of Video Games, Computers, Captions or Other Fixed Image Displays.

The extended use of fixed image program material can cause a permanent "shadow image" on the LCD panel. This background image is viewable on normal programs in the form of a stationary fixed image. This type of irreversible LCD panel deterioration can be limited by observing the following steps:

- Reduce the brightness/contrast setting to a minimum viewing level.
- Do not display the fixed image for extended periods of time.
- Turn the power off when not in actual use.

■ This product utilizes tin-lead solder, and has a fluorescent lamp containing a small amount of mercury. Disposal of these materials may be regulated in your community due to environmental considerations. For disposal or recycling information please contact your local authorities, or the Electronics Industries Alliance: www.eiae.org.

Dear Panasonic Customer

Welcome to the Panasonic family of customers.

We hope that you will have many years of enjoyment from your new LCD TV.

To obtain maximum benefit from your set, please read these instructions before making any adjustments, and retain them for future reference.

Retain your purchase receipt, and record the model number and serial number of your set in the space provided on the rear cover of these instructions.

For assistance, please call : 1-800-211-PANA (7262) or send e-mail to : consumerproducts@panasonic.com or visit us at www.panasonic.com (U.S.A)
For assistance, please call : 787-750-4300 or visit us at www.panasonic.com (Puerto Rico)
For assistance, please call : 1-800-561-5505 or visit us at www.panasonic.ca (Canada)

Federal Communication Commission Information

This equipment has been tested and found to comply with the limits for a TV Broadcast Receiver, pursuant to Part 15 of the FCC Rules. These limits are designed to provide reasonable protection against harmful interference in a residential installation. This equipment generates, uses and can radiate radio frequency energy and, if not installed and used in accordance with the instructions, may cause harmful interference to radio communications. However, there is no guarantee that interference will not occur in a particular installation. If this equipment does cause or receive interference, which can be determined by turning equipment off and on, the user is encouraged to try to correct the interference by one or more of the following measures:

- Reorient or relocate the TV antenna.
- Increase the separation between TV and other equipment.
- Connect TV into separate outlet from other equipment.
- Consult the dealer or an experienced radio/TV technician for help.

FCC Caution: Pursuant to 47CFR, Part 15.21 of the FCC rules, any changes or modifications not expressly approved by the party responsible for compliance could void the user's authority to operate this equipment.



HDMI, the HDMI logo and High-Definition Multimedia Interface are trademarks or registered trademarks of HDMI Licensing LLC.

Table of Contents

Important Safety Instructions	2	Operating peripheral equipment	
Installation	6	using the remote control	31
SUPPLIED ACCESSORIES	6	Programming The Illuminated	
Remote control battery installation	7	Remote Control Using Access Codes	31
Maintenance	7	Programming Without A Code	
Connections	8	(When the code is not known)	32
Connecting the Antenna Cable to the Antenna Terminal	8	Infrared Codes Index	33
Antenna cover removal and fitting	8	IMode Operational Key Chart	35
Antenna / Cable Connection	8		
Cable cover removal and fitting	10	Manual de instrucciones [Resumen]	
How to connect the input terminals	10	Preparación	36
How to connect the HDMI Terminal	12	Instalación de las pilas en el control remoto	36
Power ON / OFF	13	Conexión	37
Connecting the Plug to the Wall Outlet	13	Conexión del cable de antena al terminal de entrada de RF ..	37
How to Turn the Power On	13	Desmontaje e instalación de la cubierta de la antena	37
Location of Controls	14	Conexión de antena / cable	37
Illuminated Remote Control	14	Para quitar y colocar la cubierta del cable	38
Flow Chart of MENU	16	Como conectar el término del entrada/salida	38
Tuning channels		Conexión/desconexión de la alimentación ...	39
(Automatic channel programming)	18	Conexión de la clavija a la toma de corriente ...	39
Tuning channels		Cómo conectar la alimentación	39
(Manual channel programming)	19	Ubicación de los controles	40
ASPECT Controls	20	Control remoto iluminado	40
Picture Adjustments	21	Organigrama de menús de televisión	42
Position / Size Adjustment	23	Sintonización de canales	
Audio Adjustments	24	(Programación automática de canales)	44
Lock Feature	25	Sintonización de canales	
Closed Captions	29	(Programación manual de canales)	45
Customizing the VIDEO INPUT labels	30		
OTHER ADJUST	30	Troubleshooting	46
		Specifications	47

Installation

Receiver Location

Locate for comfortable viewing. Avoid placing where sunlight or other bright light (including reflections) will fall on the screen. Use of some types of fluorescent lighting can reduce remote control transmitter range.

Adequate ventilation is essential to prevent internal component failure. Keep away from areas of excessive heat or moisture.

Optional External Equipment

The Video/Audio connection between components can be made with shielded video and audio cables. For best performance, antenna cables should utilize 75 ohm coaxial shielded wire. Cables are available from your dealer or electronic supply store.

Before you purchase any cables, be sure you know what type of output and input connectors your various components require. Also determine the length of cable you'll need.

For optimum quality picture

When the LCD is exposed to light from outdoors or lighting fixtures, high-contrast pictures may not be displayed clearly. Turn off florescent lamps near the LCD and place in a location not exposed to outdoor light.

How to use the LCD stand

Adjust the stand to your desired angle. The stand angle can be adjusted between 5 ° front to 15 ° back.

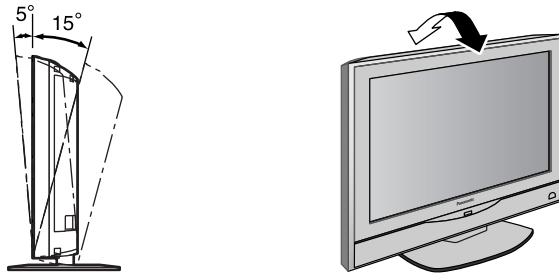

SUPPLIED ACCESSORIES

Check the accessories before installations.

- Operating Instruction book

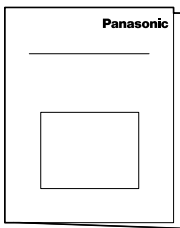

- Remote Control Transmitter



- Batteries for the Remote Control Transmitter (2 × AA size)



- Warranty Card

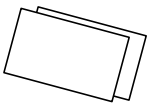

- AC Adaptor & AC Cord

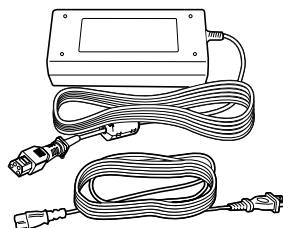

- Coaxial Antenna Plug

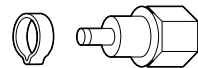

Remote control battery installation

Replacing batteries

Replace batteries by following the steps below:

Requires two AA batteries.

1. Open the battery cover.
2. Install the batteries as shown in the battery compartment. (Polarity + or – must match the markings in the compartment).
3. Replace the cover.

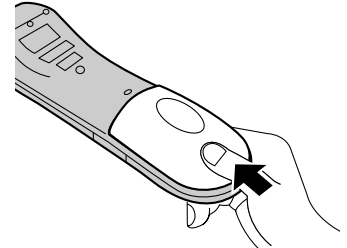
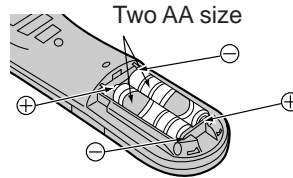
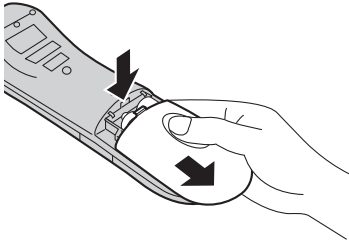

⚠️ Precaution on battery use

Incorrect installation can cause battery leakage and corrosion that will damage the remote control transmitter.

Observe the following precautions:

1. Always use new batteries when replacing the old set.
2. Do not attempt to charge, short-circuit, disassemble, heat or burn used batteries.
3. Battery replacement is necessary when remote control acts sporadically or stops operating this unit.

Notes:

- Do not drop, apply shock to or step on the remote control.
- Do not spill water on the remote control.
- Do not place objects between the remote control and remote control receiver.
- Do not use remote controls for other equipment at the same time.
- If the TV does not operate even when operating the remote control from a close range, it is time to replace the batteries.
Refer to the label on back of the remote control for directions on replacing batteries.

Maintenance

To clean this unit, wipe with a soft, dry cloth.

If the surfaces are extremely dirty, use a soft cloth dipped in a soap and water solution or a weak detergent solution.

- Use eyeglass cleaner to remove stubborn dirt from the LCD.
- Never use alcohol, paint thinner or benzene to clean this unit.
- Before using a chemically treated cloth, read the instructions that came with the cloth carefully.

CAUTION :

If water or similar substances get inside the monitor via the liquid crystal panel surface, a malfunction may result.

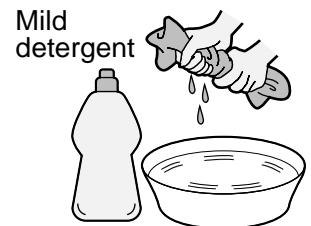

Connections

Connecting the Antenna Cable to the Antenna Terminal

Antenna Connection - For proper reception of VHF/UHF channels, an external antenna is required. For best reception an outdoor antenna is recommended. Antenna Mode must be set to TV.

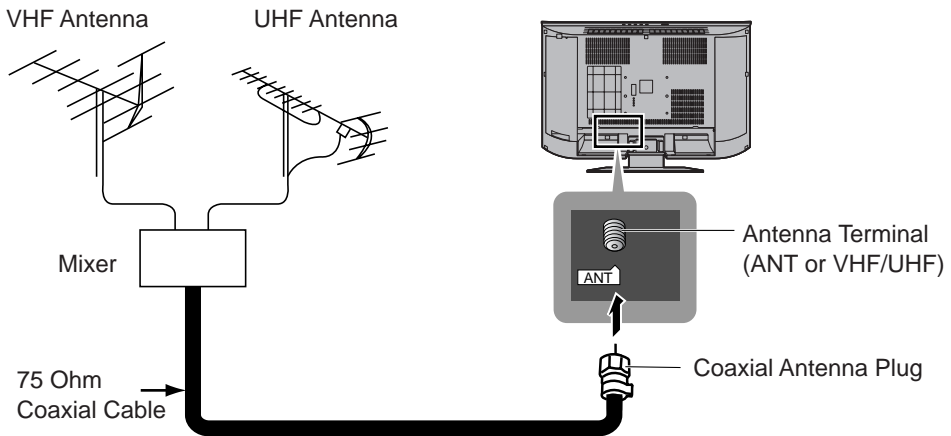

Antenna cover removal and fitting

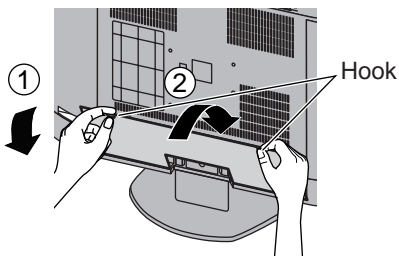

① Removal

1. Push up hooks and pull the cover slightly towards yourself to disengage the claws (at 4 points).
2. Slowly pull out in the downward direction.

② Fitting

1. Insert the claws (at 4 points) at the bottom end.
2. Push it until hook is locked.

Note:

To avoid interference appearing on the screen, do not bundle the antenna wire and AC adapter wire together.

Antenna / Cable Connection

Incoming 75 Ohm Cable from Home Antenna / Cable Company

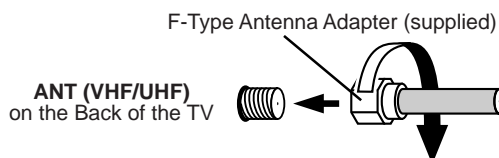

Cable Connection - For reception of cable channels (01 - 125) connect the cable supplied by your local cable company. Antenna Mode must be set to CABLE. (Refer to Antenna Mode section.)

Note:

Certain cable systems offset some channels to reduce interference or have Premium (scrambled) channels. A cable converter box is required for proper reception. Check with your local Cable company for its compatibility requirements.

Antenna Connection (Cable Box, no VCR)

Use this configuration when connecting the TV to a cable TV system using a Cable Box.

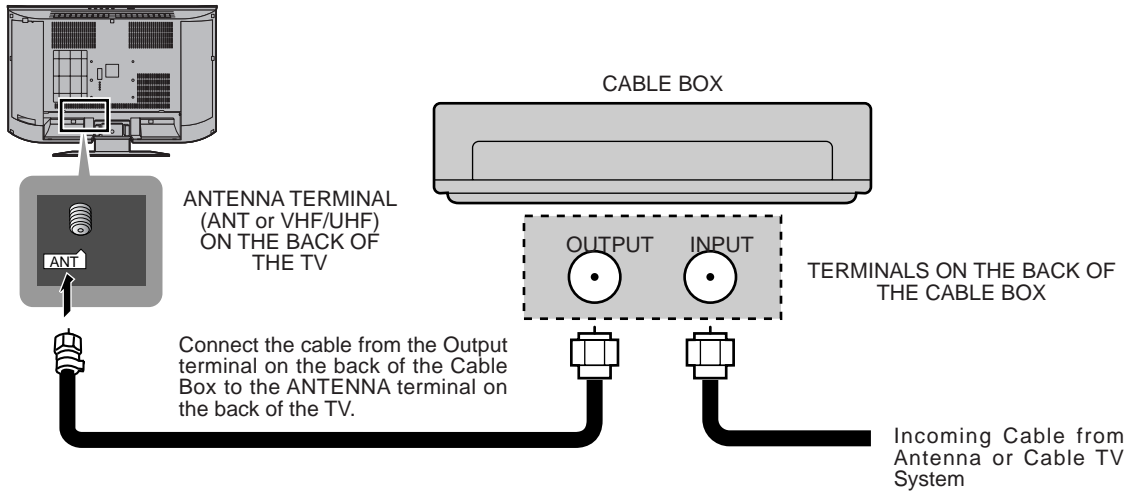

Antenna Connection (Cable Box, and VCR)

Use this configuration when connecting the TV to a cable TV system using a Cable Box and VCR.

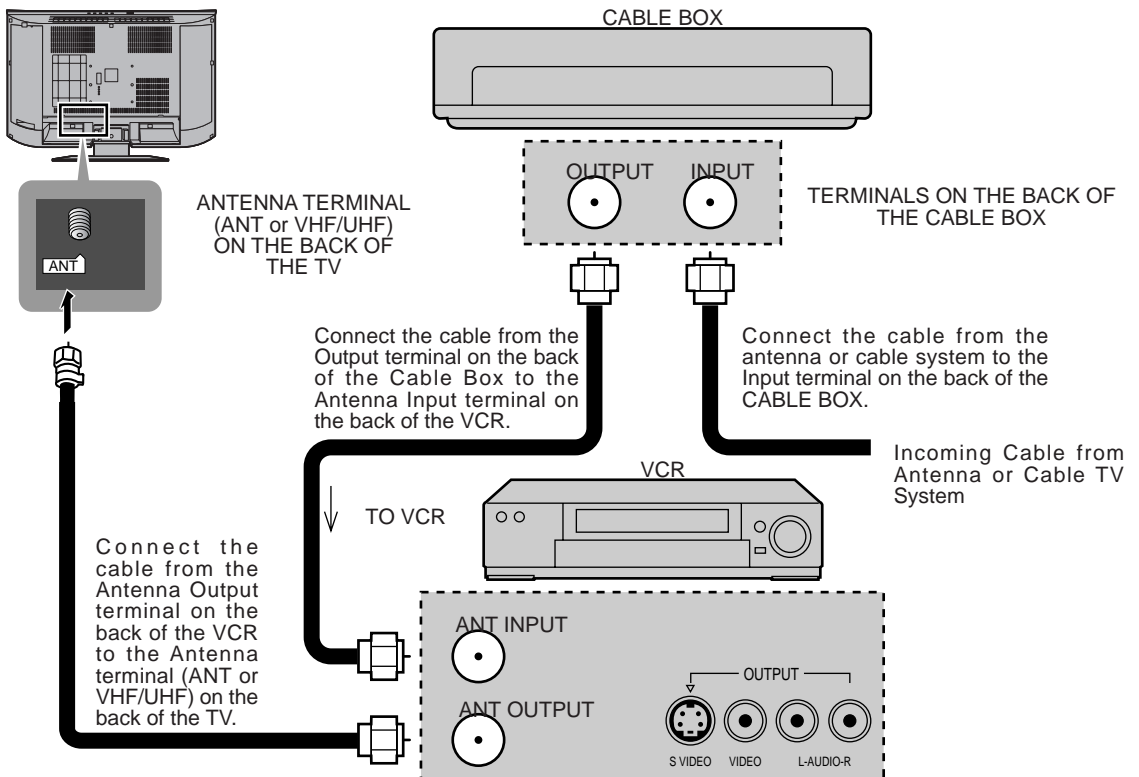

Note:

When the antenna cable is connected to the TV antenna terminal via a cable box or VCR, set the TV channel to CH3 or CH4, cable. This does not apply when signal is input from VIDEO INPUT.

Cable cover removal and fitting

Removal

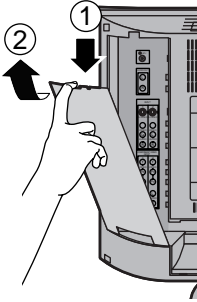

1. Disengage the claws at the uppermost end.
2. Slowly pull out in the upward direction.

Fitting

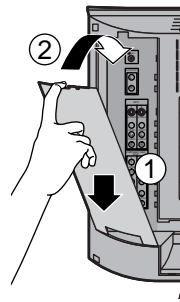

1. Insert the claws (at 2 points) at the bottom.
2. Push in the TOP.

Note:

Depending on the type of cable used it may not be possible to close the cover. In such cases the cable may be routed through the antenna cover.

How to connect the input/output terminals

Connect camcorder and video game console.

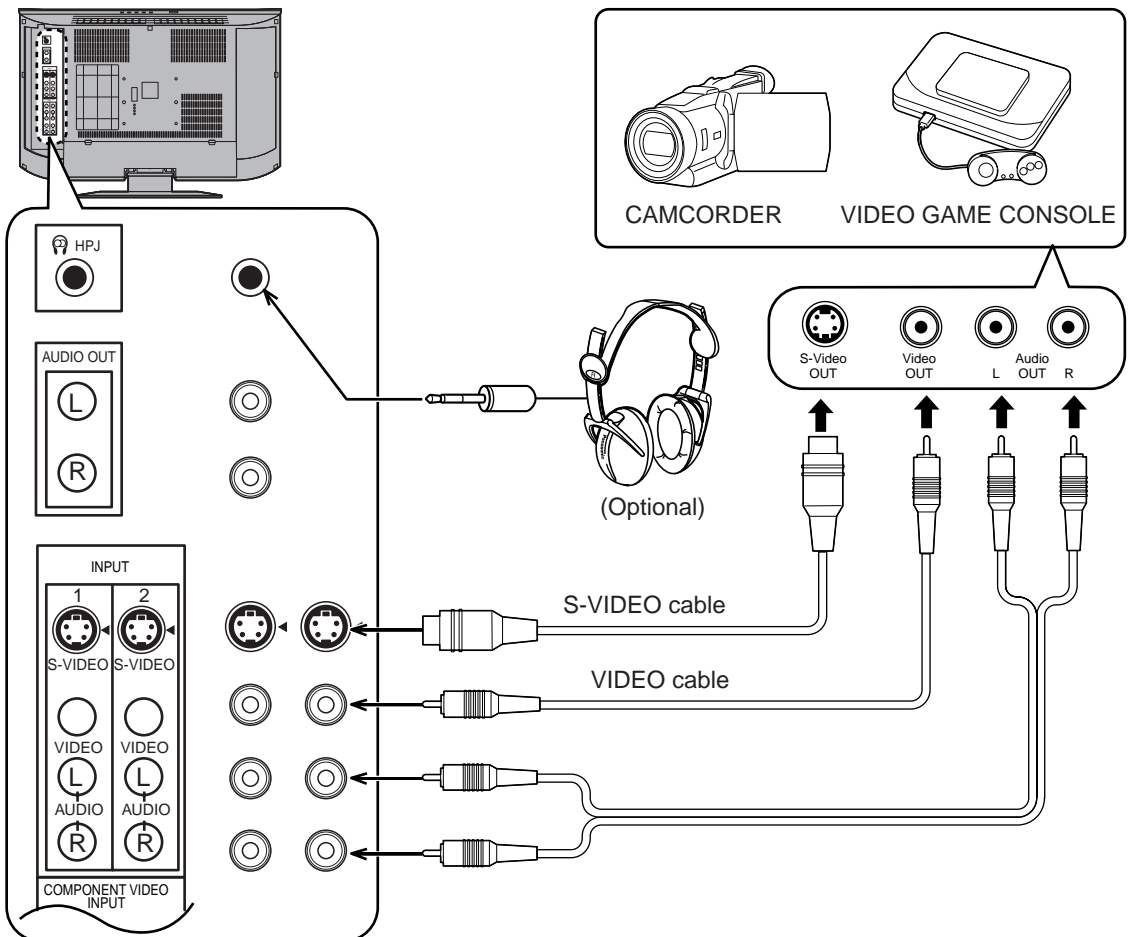

Connect VCR and other peripheral equipment

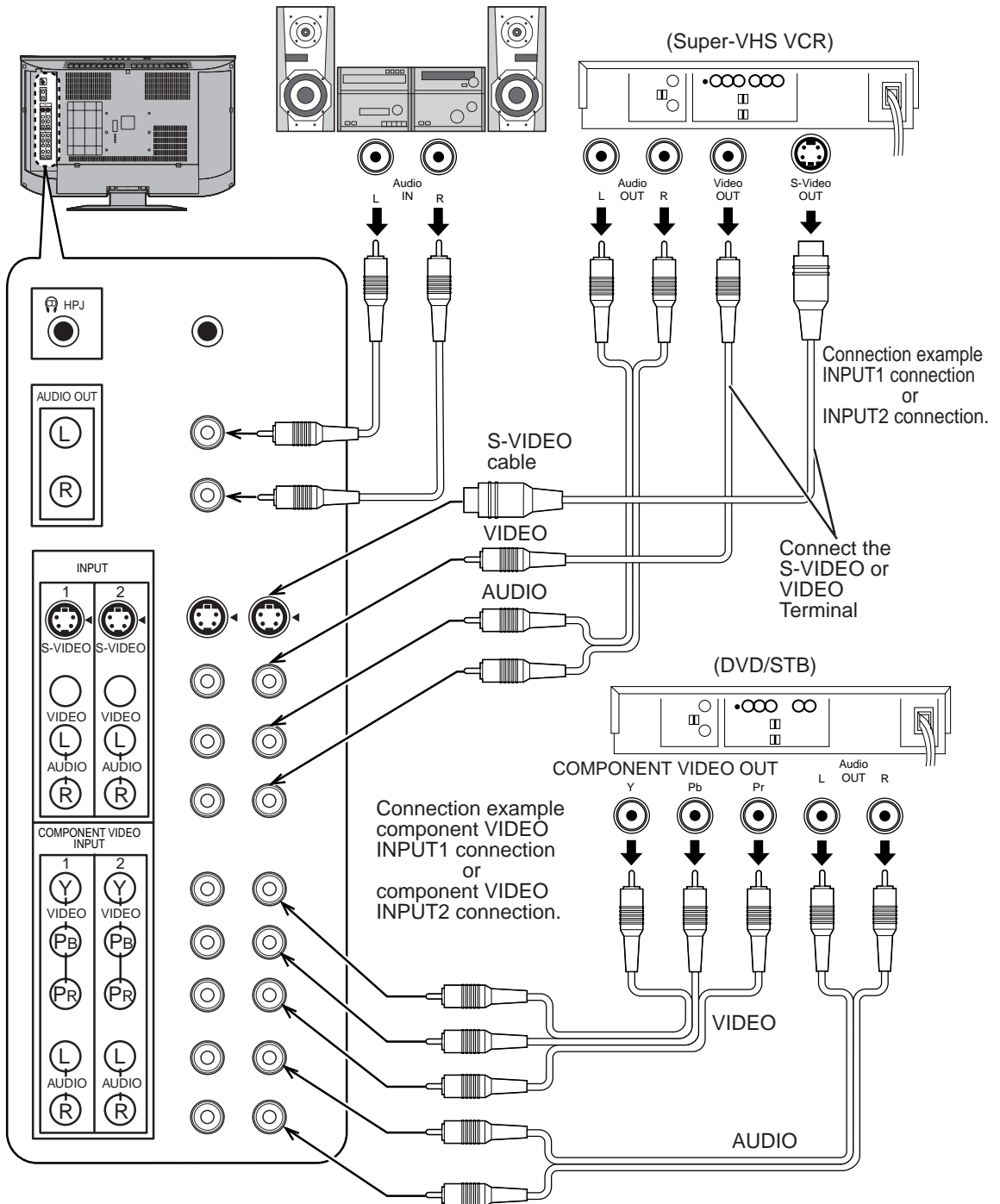

Notes:

- When connecting video cables, priority is given to the S-Video cable when the S-Video input terminal and the video input terminal are connected at the same time.
- The volume control output of the LCD TV will be fixed. (SOUND, ADJUST, VOLUME UP/DOWN and SURROUND ON/OFF are not functional for output signals from the AUDIO OUT terminals.)

How to connect the HDMI Terminal

HDMI*¹ (HDMI : High Definition Multimedia Interface) is the first all digital consumer electronics A/V interface that supports uncompressed standard. One jack supports both video and audio information. This HDMI*¹ input can be connected to an EIA/CEA-861/861B*² compliant consumer electronic device, such as a Set Top Box or DVD player equipped with HDMI or DVI output connection.

By inputting a High-bandwidth Digital Content Protection (HDCP) high-definition picture source to the HDMI terminal of this television, high-definition pictures can be displayed on the screen in their digital form.

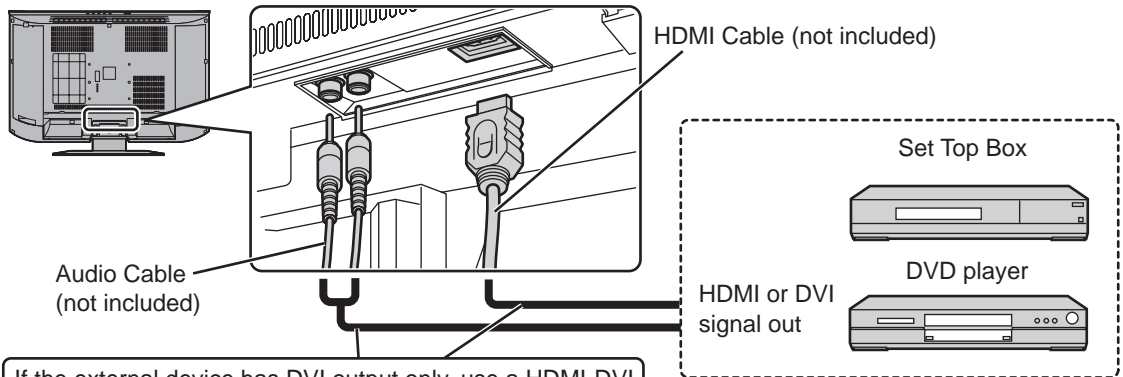

If the external device has DVI output only, use a HDMI-DVI conversion cable*³ to connect to the HDMI jack on the LCD. Also, connect the Audio out signal from the external device. (Set Top Box or DVD player) to the AUDIO IN*⁴ jacks beside the HDMI input.

Applicable VIDEO Signal

This model support following format.
Please adjust the format of connecting equipment.

	No. of dots (H × V)	Vertical scanning frequency(Hz)
1080i	1,920 × 1,080i	59.94/60
480P	720 × 480P	59.94/60
	640 × 480P	59.94/60
480i	720(1,440) × 480i	59.94/60

This input terminal is not intended for use with computers.

AUDIO signal (L.PCM)

When the digital sound signal is included at connecting HDMI equipment, L.PCM sound is available.

Sampling frequency
48KHz / 44.1KHz / 32 KHz

Notes:

- (1) This HDMI connector is Type A.
- (2) If you cannot display the picture because your Digital Set Top Box does not have a Digital OUT terminal Output setting, use the component Video input (or the S video Input or Video Input). In this case the picture will be displayed as an analog signal.

- *1. HDMI, the HDMI logo and High-Definition Multimedia Interface are trademarks or registered trademarks of HDMI Licensing LLC.
- *2. EIA/CEA-861/861B profiles compliance covers profiles for transmission of uncompressed digital video including high bandwidth digital content protection.
- *3. HDMI-DVI conversion cable part no. (TY-SCH03DH):available on Panasonic Website (USA only) (www.panasonic.com)
- *4. AUDIO-IN, Please refer to page 24. (HDMI-IN)

Power ON / OFF

Connecting the Plug to the Wall Outlet

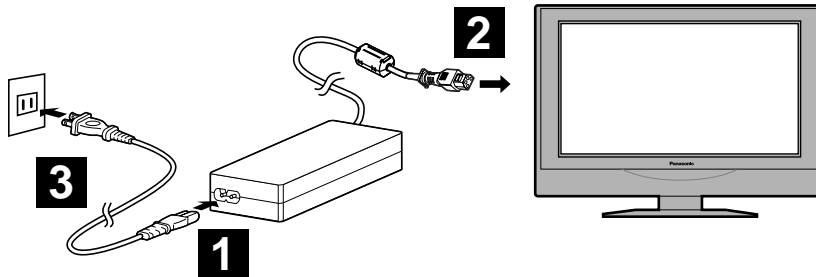

Note:

The TV's power cord must first be plugged into the wall outlet.

How to Turn the Power On

Main POWER switch

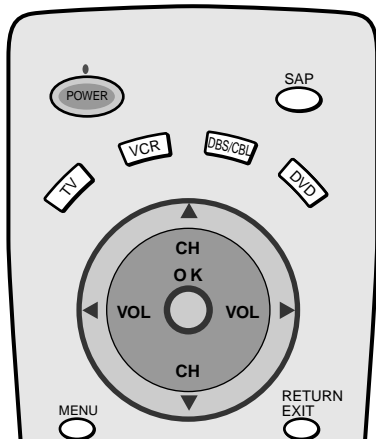
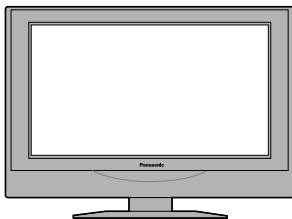
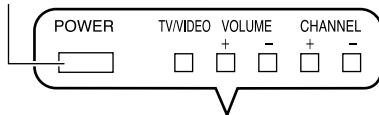

Press the Main POWER switch on the top of TV to turn the set on.

POWER-ON: Green

When the set is on or in standby mode press the Main POWER switch on the TV to turn the set off.

POWER-OFF: No light

Example: The screen below is displayed for a while after the TV is turned on. (setting condition is an example.)

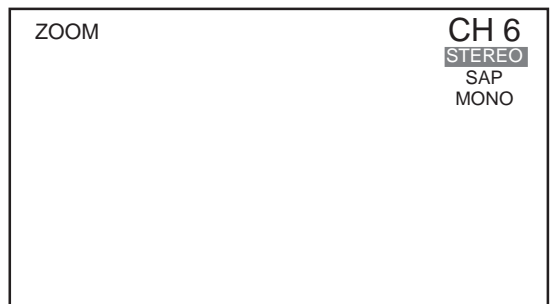

POWER — Press the POWER button on the remote control to turn the TV off: Red (standby)

Press the POWER button on the remote control to turn the TV on: Green

Note:

The TV will still consume some power as long as the power cord is still plugged into the wall outlet.

Location of Controls

Illuminated Remote Control

Power button

Press to turn the TV ON or OFF.

Note: The TV's power cord must first be plugged into the wall outlet and then turned on at the POWER switch (standby mode).

Mode Selection buttons

VCR Mode Selection for Remote Control

Digital Broadcasting Satellite for Remote Control / Cable TV Mode Selection for Remote Control

TV Mode Selection for Remote Control

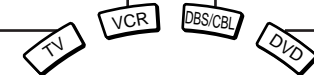

Digital Video Disc Mode Selection for Remote Control

R-TUNE



R-TUNE button

Switches to previously viewed channel or video mode.

Operation of other Device

Buttons \ Device	REW / FF 	PLAY 	PAUSE 	STOP
VCR	VCR REW/FF	PLAY	Pause	STOP
CABLE/DBS	—	—	—	—
DVD	Skip Search REW/FF	PLAY	Pause	STOP

Buttons \ Device	REC 	ASPECT TV/VCR 	VCR/DBS CH
VCR	VCR RECORD	TV/VCR Switch	VCR CH up/down
CABLE/DBS	—	STB—ASPECT	PAGE up/down
DVD	—	Open / Close	Slow/+/-

ASPECT TV/VCR



ASPECT button

Change of screen size (See page 20).



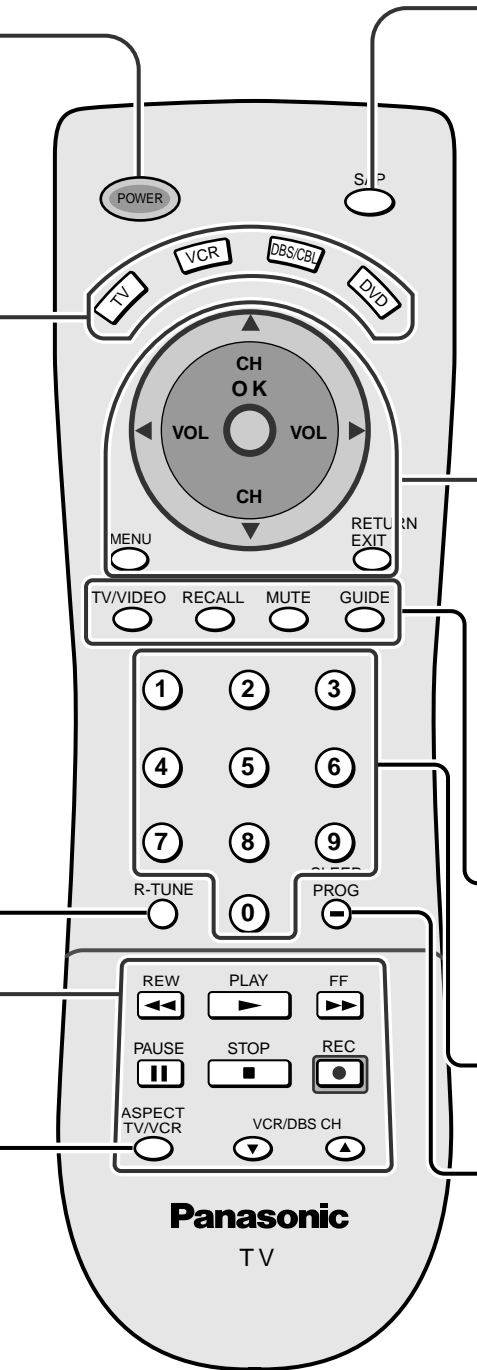

SAP button

Selects Audio mode (See page 24).



Changes to the next channel up
Moves cursor upward during menu mode.

Reduces volume
Moves cursor to the left during menu mode.

Increases volume
Moves cursor to the right during menu mode.

Displays menu
Press to access TV, DTV, DBS or DVD menus.

Changes to the next channel down
Moves cursor downward during menu mode.

Press to Return to previous MENU or EXIT from menu.

The input mode changes each time this button is pressed.

Press this button to mute the sound, press again to cancel the mute

GUIDE button for DBS.

Press to display the current system status, for example, Aspect mode, Channel number, Stereo mode, Picture menu, TV/VIDEO, Power save, Off timer and Color system.

Direct program number selection buttons



PROG dash button / SLEEP TIMER button

Program dash channel numbers for DTV and DBS.
Sleep timer (MINUTES)

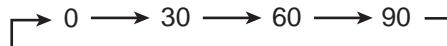

Flow Chart of MENU

All adjustments and setting functions available in this set can be made using the menu buttons. The menu screen is composed of 2 menus: the ADJUST menu and the SET UP menu.

1

Press to display MENU screen, press again to clear.

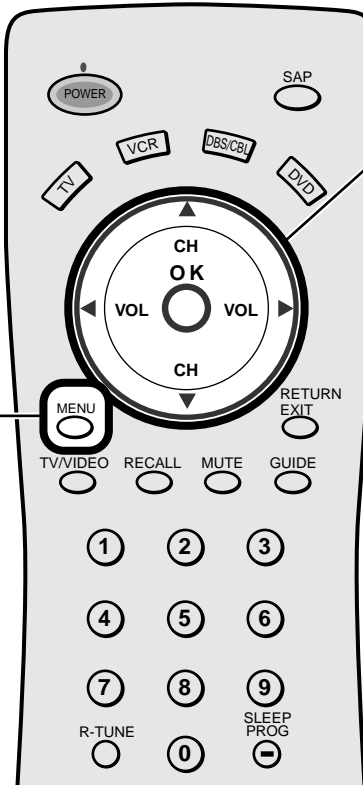
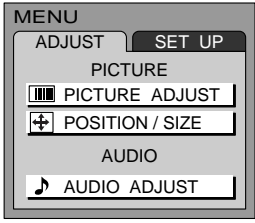

2

MENU selection

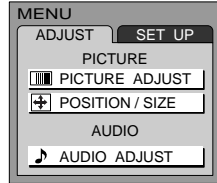

OR

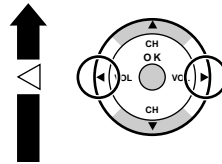
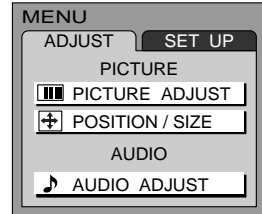
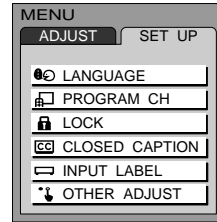

Please refer to the On Screen Help

An On Screen Help box is displayed whenever a menu is displayed on the TV. This Help box indicates which keys on the remote control are used to navigate the menu shown. See above for descriptions of button functions.

ON SCREEN HELP
'Instruction' box

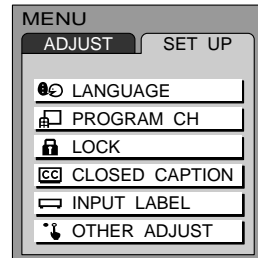
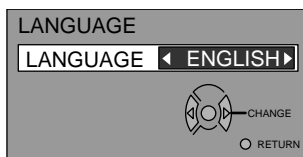

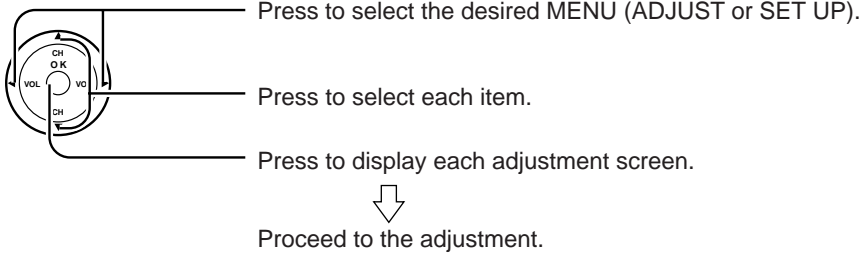

- To return to previous screen : Press to return.
- To end adjustments : Press to exit from the MENU screen. This returns the set to the normal viewing condition.

Press to display each adjustment screen.

OK

RETURN
EXIT

Press the RETURN button to return to previous screen.

TO PICTURE ADJUST menu

PICTURE ADJUST	
	NORMALIZE
PIC MODE	STANDARD
BACK LIGHT	+ 20
PICTURE	+ 20
BRIGHTNESS	0
COLOR	- 1
TINT	0
SHARPNESS	0
AI PICTURE	OFF ON

(See page 21)

POSITION/SIZE	
NORMAL	
	NORMALIZE
	SIZE
	1
	RETURN

TO AUDIO ADJUST menu

AUDIO ADJUST	
	NORMAL
MODE	DYNAMIC
BASS	+ 10
TREBLE	+ 8
BALANCE	0
SURROUND	OFF ON
STEREO	SAP MONO
HDMI IN	AUTO

(See page 24)

Press to display each adjustment screen.

OK

RETURN
EXIT

Press the RETURN button to return to previous screen.

TO LANGUAGE

LANGUAGE	
LANGUAGE ENGLISH	
Allows you to select the language used for On Screen Displays.	
ENGLISH FRANÇAIS	
ESPAÑOL	

TO CLOSED CAPTION

CLOSED CAPTION	
CC ON MUTE	NO
CC MODE	OFF

(See page 29)

TO PROGRAM CHANNELS

PROGRAM CHANNELS	
MODE	TV CABLE
AUTO PROGRAM	
MANUAL PROGRAM	

(See page 18,19)

TO OTHER ADJUST screen

OTHER ADJUST	
VIDEO NR	OFF ON
3D Y/C	OFF ON
COLOR MATRIX	SD HD
POWER SAVE	STANDARD

(See page 30)

TO LOCK selection screen

LOCK	
BLOCK PROGRAMS	
U. S. MOVIES	
STATUS	OFF ON
CHANGE SETTING	
ENTER CODE FIRST	

(See page 25)

TO INPUT LABEL selection screen

INPUT LABEL	
COMPONENT1	COMPONENT1
COMPONENT2	COMPONENT2
VIDEO1	VIDEO1
VIDEO2	VIDEO2
HDMI	HDMI

(See page 30)

Tuning channels (Automatic channel programming)

Automatically scans all TV channels and stores them in memory.

1 Turn the Power on and press the TV/VIDEO button to display the TV channel.

2 Press the MENU button to display the MENU screen and select SET UP.

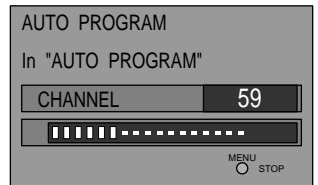
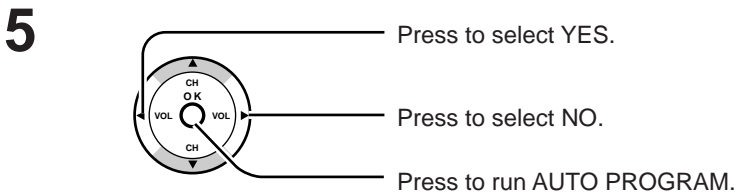
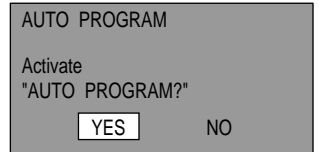
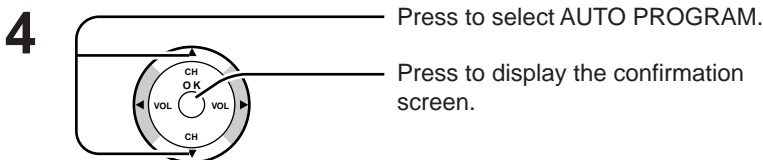
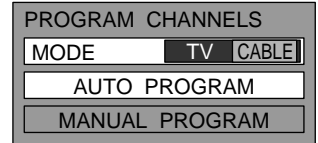
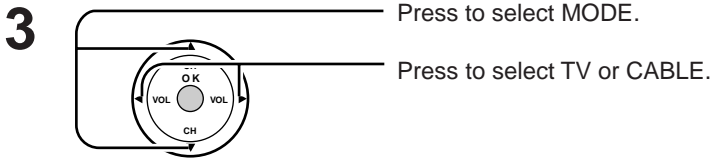
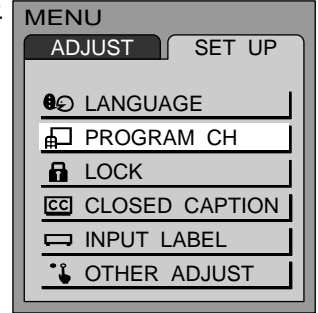
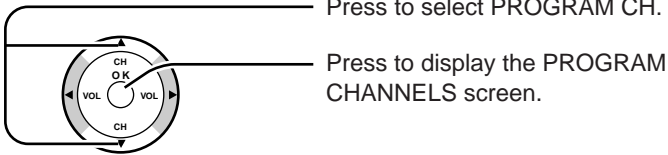

Channels will automatically advance until all channels have been scanned. Channel numbers with a video signal present will be stored in the Channel Scan Memory.

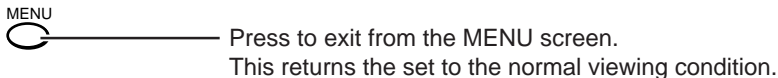

Notes:

- When buttons are pressed with AUTO PROGRAM running, the TV set will return to normal viewing. (Channels searched up to this point are added.)
- After AUTO PROGRAM is finished, the lowest channel number added will be received.
- When there are no receivable channels, channel 69 is displayed for TV and channel 125 is displayed for cable TV.

Tuning channels (Manual channel programming)

Use this setting when changing setting of receiving channels or changing the channel display.

Turn the TV on and select the broadcast channel. Follow the steps on the previous page to display the PROGRAM CHANNELS screen.

1

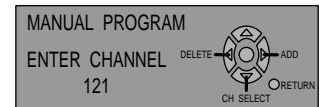
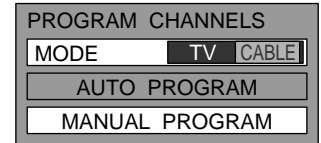
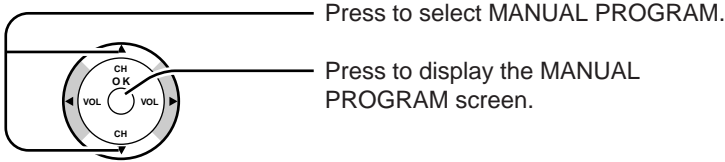

Adding or deleting channels

2

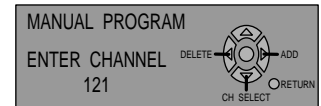
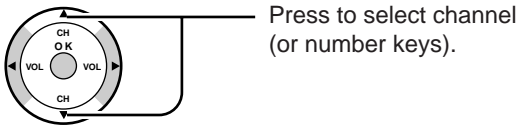

3

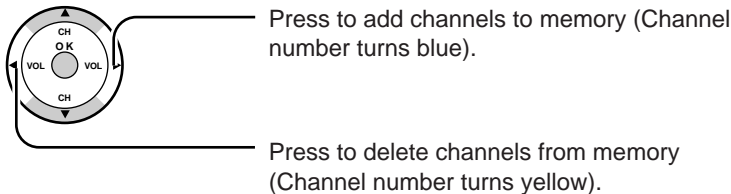

4 Repeat steps 2 and 3 to continue adding or deleting channels.

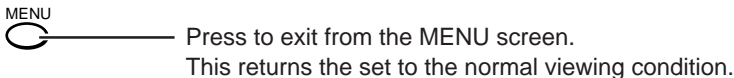

ASPECT Controls

The color monitor will allow you to enjoy viewing the picture at its maximum size, including wide screen cinema format picture.

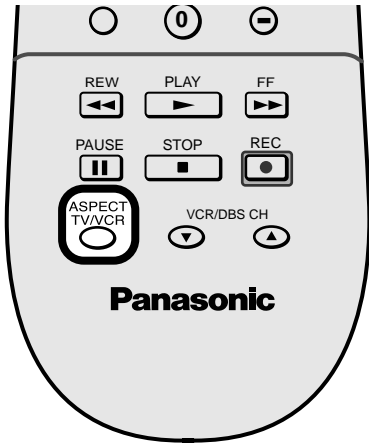

ASPECT button

The aspect mode changes each time the ASPECT button is pressed.



Note:

When a 1080i signal is being received, the mode is set to FULL, and aspect switching is not possible.

Mode	Picture	Explanation
NORMAL		Normal mode will display a 4:3 picture at its standard 4:3 size.
JUST		JUST mode will display a 4:3 picture at its maximum size but with aspect correction applied to the sides of the screen so that elongation is only apparent at the left and right edges of the screen. The size of the picture will depend on the original signal.
ZOOM		ZOOM mode magnifies the central section of the picture.
FULL		FULL will display the picture at its maximum size but with slight elongation.

Picture Adjustments

- 1** Press the MENU button to display the MENU screen and select ADJUST.

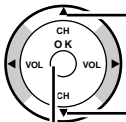

Press to select PICTURE ADJUST.

Press to display the PICTURE ADJUST screen.

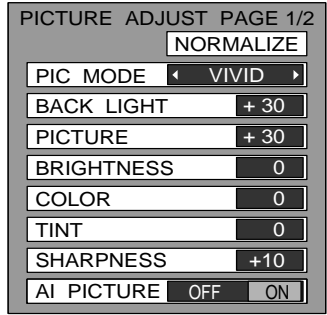
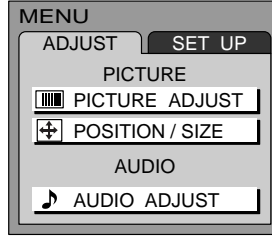

- 2**

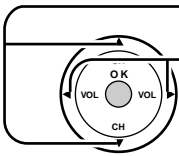

Press to select the menu to adjust.

Select the desired level by looking at the picture behind the menu.

NORMAL is displayed at default.

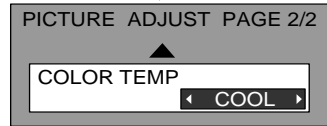

PIC MODE

PICTURE MODE is stored for TV, VIDEO1, VIDEO2, COMPONENT1, COMPONENT2 and HDMI individually.

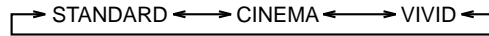

MODE	Function
STANDARD	Displays standard image.
CINEMA	Ideal for watching movies in a dark room.
VIVID	Displays a clear screen with contrast of light and dark.

BACK LIGHT, PICTURE, BRIGHTNESS, COLOR, TINT, SHARPNESS, AI PICTURE, COLOR TEMP

You can change the level of each item (BACK LIGHT, PICTURE, BRIGHTNESS, COLOR, TINT, SHARPNESS, AI PICTURE and COLOR TEMP) for each MENU (STANDARD, CINEMA, and VIVID) according to your personal preference.

Item	Function
BACK LIGHT	Luminance of the back light is adjusted.
PICTURE	Selects proper brightness and density for the room.
BRIGHTNESS	Adjusts for easier viewing of dark pictures such as night scenes.
COLOR	Adjusts the level of color.
TINT	Adjusts for flesh tone color.
SHARPNESS	Adjusts the degree of sharpness.
AI PICTURE	Displays black and white colors more clearly when turned ON.
COLOR TEMP	Increase or decrease WARM (red) and COOL (blue) colors to suit personal preference.

- To reset to standard setting :

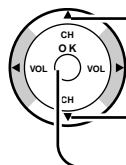

Press to select NORMALIZE.

Press OK.

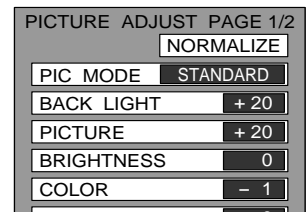

Picture Adjustments

3 ADVANCED ADJUST

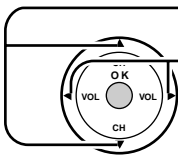

Press to select PIC MODE.

Select STANDARD or CINEMA.

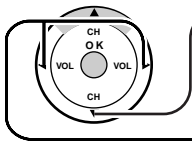

Press down to PAGE 2 and select ADVANCED ADJUST.

Press to select ADVANCED ADJUST ON.

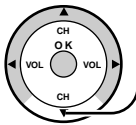

Press to go to NEXT PAGE.
ADVANCED ADJUST will be shown.

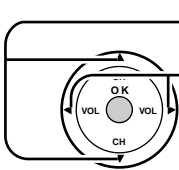

Press to select the menu to adjust.

Select the desired level by looking at the picture behind the menu.

NORMAL is displayed at default.

PICTURE ADJUST PAGE 1/2

NORMALIZE

PIC MODE **STANDARD**

BACK LIGHT **+ 20**

PICTURE **+ 20**

BRIGHTNESS **0**

COLOR **- 1**

TINT **0**

SHARPNESS **0**

AI PICTURE **OFF ON**

COLOR TEMP

◀ NORMAL ▶

ADVANCED ADJUST

OFF ON

ADVANCED ADJUST

NORMAL

BLACK EXTENSION **+ 8**

WHITE CHAR CORR **+ 8**

MPEG NR **0**

Item	Function
BLACK EXTENSION	Contrast level will be improved.
WHITE CHAR CORR	It makes white characters brighter.
MPEG NR	Noise unique to DVD, STB etc will be reduced.

Position / Size Adjustment

This function will adjust the picture position / size for easy viewing.

- 1** Press MENU button to display MENU screen and select adjust.

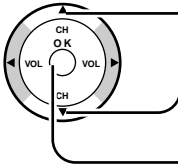

Press to select POSITION/SIZE.

Press to display POSITION/SIZE control.

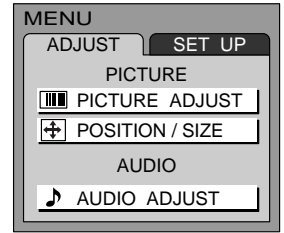

- 2** [Picture Position Adjustment]

It will work for "ZOOM" mode only.

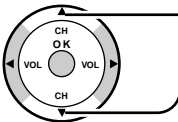

Press to move picture vertically for the best view.

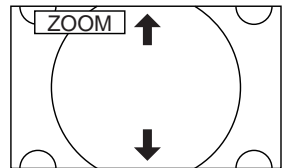
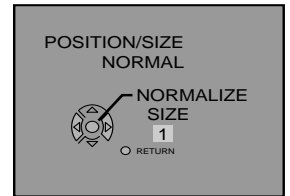

- 3** [Picture Size Adjustment]

It will work for "NORMAL" and "JUST" mode only.

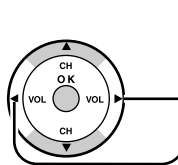

Press to select.
size 1: reduced black bar.
size 2: widened black bar.

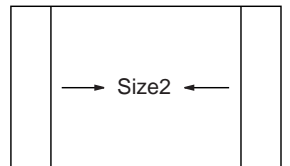
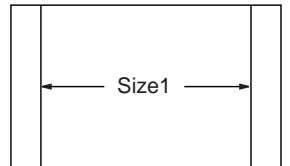

- To return to previous screen : Press to return.

- To reset to standard setting : Press OK.

Audio Adjustments

1 Press the MENU button to display the MENU screen and select ADJUST.

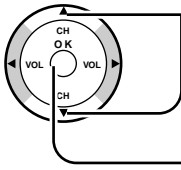

Press to select AUDIO ADJUST.

Press to display the AUDIO ADJUST screen.

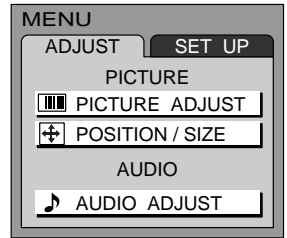

2

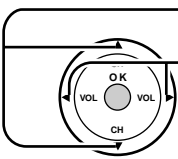

Press to select the menu to adjust.

Select the desired level by listening to the sound.

NORMAL is displayed at default.

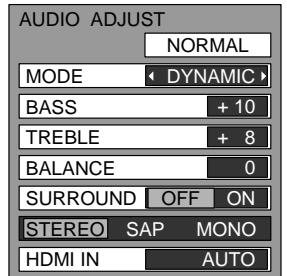

MODE



MODE	Function
AUTO	Automatically adjusts quiet sound and loud sound for ease of listening.
STANDARD	Emits the original sound.
DYNAMIC	Gives contrast to sound.

BASS, TREBLE, BALANCE, SURROUND

You can change the level of each item (BASS, TREBLE, BALANCE and SURROUND) for each MODE (AUTO, STANDARD and DYNAMIC) according to your personal preference.

Item	Function
BASS	Adjusts low sounds
TREBLE	Adjusts high sounds
BALANCE	Adjusts left and right volume
SURROUND	To enjoy a concert hall effect, turn SURROUND to ON when a stereo signal is available.

Selecting STEREO/SAP/MONO



Note:

Red display : With signal
White display : No signal
White display : MONO

MODE	Function
STEREO	Two channel Audio reception.
SAP	Second Audio Programming (typically used for bilingual audio).
MONO	Use when stereo signal is weak.

HDMI IN

Perform input switching of analog audio input (for DVI) and digital audio input (for HDMI) when using the HDMI terminal.



AUTO	Set use of analog audio input when digital audio signal is not available.
DIGITAL	Forces use of digital audio input signal transmitted via the HDMI terminal.
ANALOG	Forces use of analog audio input signal transmitted via separate RCA terminals.

Lock Feature

In the United States, the V-CHIP consists of two rating systems, which are MPA (MOTION PICTURE) and TV PARENTAL GUIDELINES. Its function is to block programs by the rating data in the XDS data packets sent from broadcasting stations. The user can select which rating programs should be blocked by the LOCK MENU options.

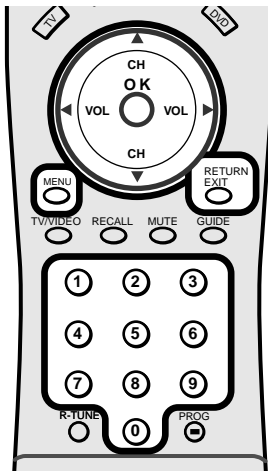

Press the MENU button to display the MENU screen and select SET UP.

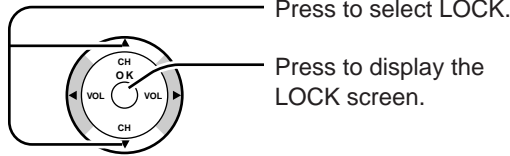

Input code

Enter any 4-digit number as a password. These numbers will be needed when deactivating the LOCK function.

While entering a code, by pressing the up or down buttons you can input a new code again.

After entering your secret code for the first time, the onscreen display will change to CHANGE CODE. And you can change the Input code.

Note: Use a code that is easy to remember and record it in a safe place.

1 Selecting broadcasts to lock.

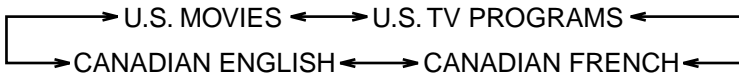
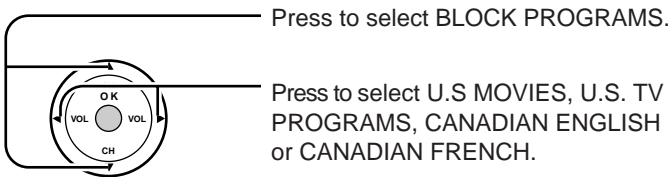

2 Press to select STATUS.

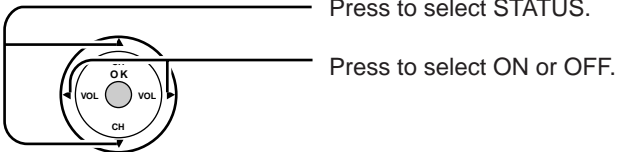

3 Press to select CHANGE SETTING.

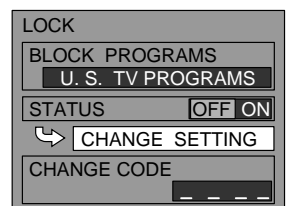
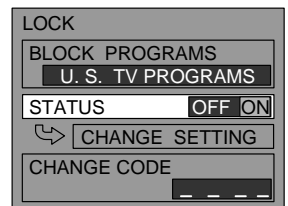
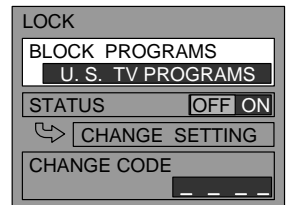
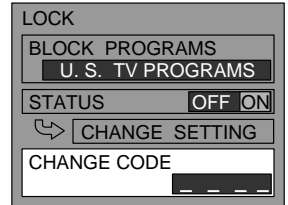
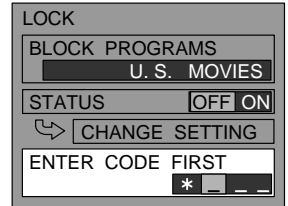
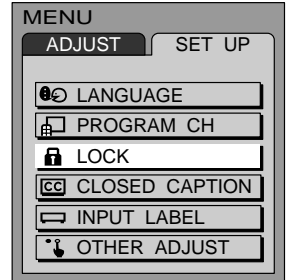
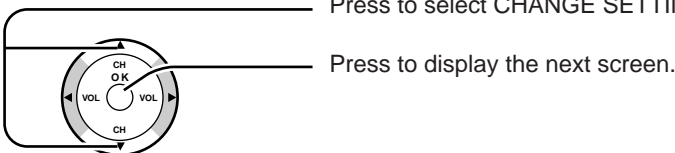

Lock Feature

for U.S.TV PROGRAM to lock

1

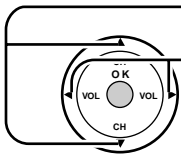

Press to select VIEW NR PROGRAMS?.

Press to select NO or YES.

NO : Cannot view programs with NR signals.

YES : Can view programs with NR signal.

2

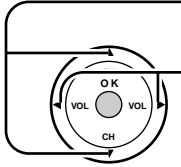

Press to select SETTING.

Press to select BASIC or DETAILED.

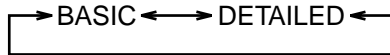

3

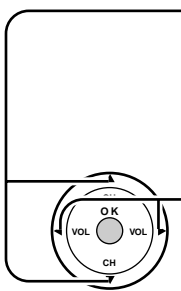

Press to select rating.

BASIC : Change the selected title.

DETAILED : The cursor selecting the title can be moved to select options displayed on the right.

Press to lock or unlock the rating.

Lock : Red

Unlock : Green

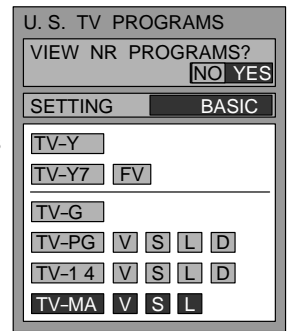
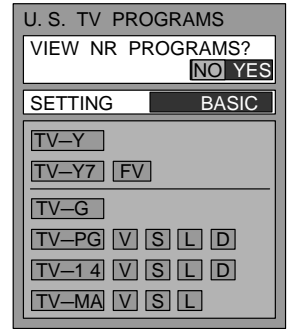

Locking and unlocking

- When a title field is selected, all ratings below this rating are selected.
- When options within an option field are selected, ratings below this rating within the same field are selected.
- Ratings displayed in green are unlocked and those displayed in red are blocked programs.

1. Ratings for children: These ratings are divided into ranks as follows.

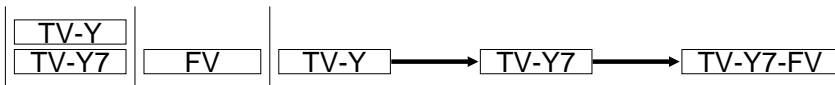

2. Ratings for teenagers: These ratings can be created out of these major categories to form various combinations. These combinations are described in the below diagram. Ratings for all ages are on top and ratings for adults are on the bottom.

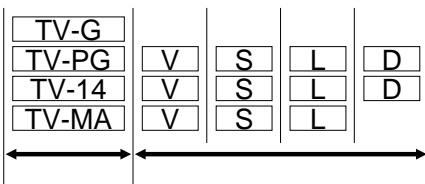

- To return to previous screen :



Press to return.

- To end adjustments :



Press to exit from the MENU screen.

This returns the set to the normal viewing condition.

for U.S.MOVIES to lock

1

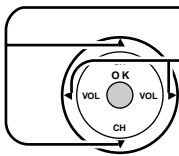

Press to select VIEW NR PROGRAMS?.

Press to select NO or YES.

NO : Cannot view programs with NR signals.
YES : Can view programs with NR signal.

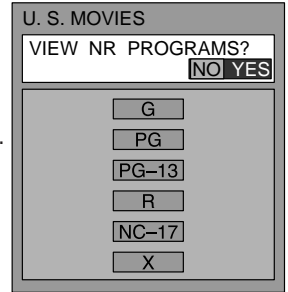

2

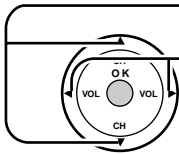

Press to select rating.

Press to lock or unlock the rating.

Lock: Red
Unlock : Green

Rating

G : General audience
PG : Parental guidance suggested
PG-13 : Parental guidance needed
under 13 years old
R : Restricted
NC17 : No one under 17 is admitted
X : Pornography

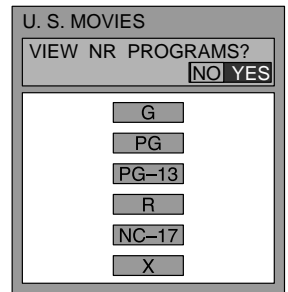

for CANADIAN ENGLISH / CANADIAN FRENCH to lock

1

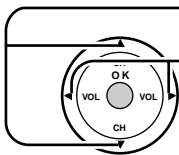

Press to select VIEW E PROGRAMS?.

Press to select NO or YES.

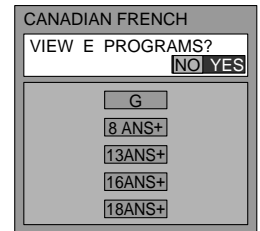
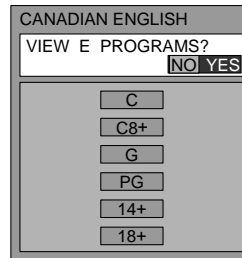

2

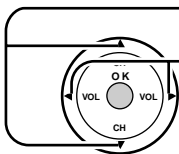

Press to select rating.

Press to lock or unlock the rating.

Lock: Red
Unlock : Green

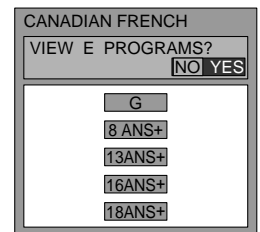
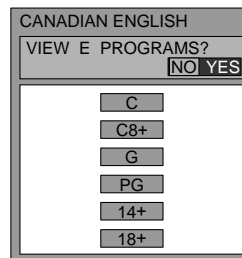

Lock Feature

CANADIAN ENGLISH RATINGS CHART

E	Exempt - Exempt programming includes: news, sports, documentaries and other information programming, talk shows, music videos, and variety programming.
C	Programming intended for children under age 8. No offensive language, nudity or sexual content.
C8+	Programming generally considered acceptable for children 8 years and over. No profanity, nudity or sexual content.
G	General programming, suitable for all audiences.
PG	Parental Guidance suggested. Some material may not be suitable for children.
14+	Programming contains themes or content which may not be suitable for viewers under the age of 14. Parents are strongly cautioned to exercise discretion in permitting viewing by pre-teens and early teens.
18+	18+ years old. Programming restricted to adults. Contains constant violence or scenes of extreme violence.

CANADIAN FRENCH RATINGS CHART

E	Exempt - Exempt programming.
G	General - Programming intended for audience of all ages. Contains no violence, or the violence content is minimal or is depicted appropriately.
8 ANS+	8+ General - Not recommended for young children. Programming intended for a broad audience but contains light or occasional violence. Adult supervision recommended.
13ANS+	Programming may not be suitable for children under the age of 13 - Contains either a few violent scenes or one or more sufficiently violent scenes to affect them. Adult supervision strongly suggested.
16ANS+	Programming may not be suitable for children under the age of 16 - Contains frequent scenes of violence or intense violence.
18ANS+	18+ years old. Programming restricted to adults. Contains constant violence or scenes of extreme violence.

- To return to previous screen :



Press to return.

- To end adjustments :



Press to exit from the MENU screen.

This returns the set to the normal viewing condition.

Closed Captions

This unit has a built in decoder that provides a visual depiction of the audio portion of a television program in the form of written words across the screen (white or colored letters on a black background). It allows the viewer to read the dialogue of a television program or other information.

1 Press the MENU button to display the MENU screen and select SET UP.

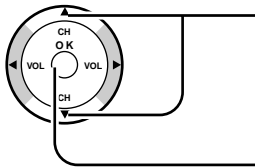

Press to select CLOSED CAPTION.

Press to display the CLOSED CAPTION screen.

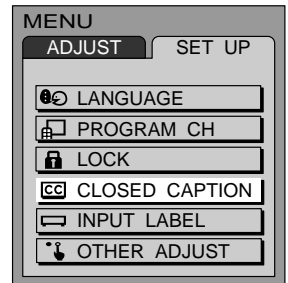

2 **CC** ON MUTE

Activates the On-Screen Closed Caption feature, when the MUTE button on the Remote Control is pressed. To deactivate, press the MUTE button again.

Note:

This feature functions when the Closed Caption Mode is in the "OFF" position. The program being viewed must be broadcast with Closed Caption.

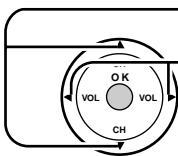

Press to select **CC** ON MUTE.

Press to select from the following:

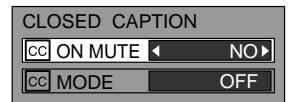
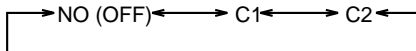

3 **CC** MODE

Activates the On-Screen Closed Caption feature. When activated this feature will remain on until OFF is selected in this menu.

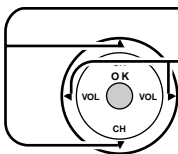

Press to select **CC** MODE.

Press to select from the following:

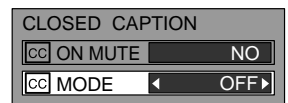
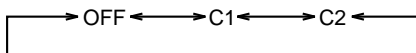

- **CAPTION OFF** - Recommended mode when Closed Caption is not being used.
- **CAPTION C1** - For video related information that can be displayed (up to 4 lines of script strategically placed on the television screen so that it does not obstruct relevant parts of the picture).
- **CAPTION C2** - Another mode used for video related information.

● To return to previous screen :



Press to return.

● To end adjustments :



Press to exit from the MENU screen.

This returns the set to the normal viewing condition.

Customizing the VIDEO INPUT labels

Display for each VIDEO INPUT can be changed to match with the connected device (VCR, DVD Player etc.).

1 Press the MENU button to display the MENU screen and select SET UP.

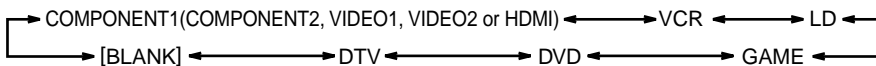
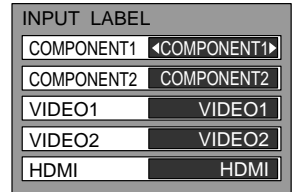
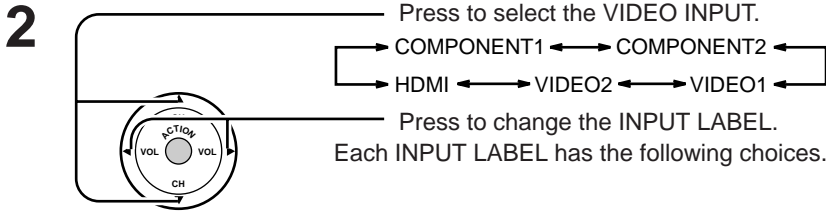
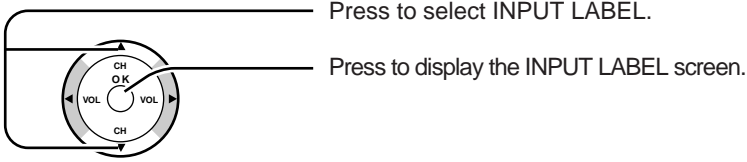
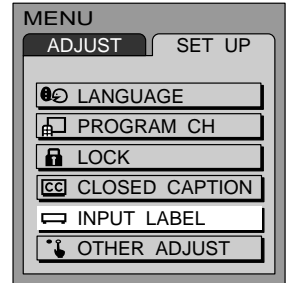

OTHER ADJUST

1 Press the MENU button to display the MENU screen and select SET UP.

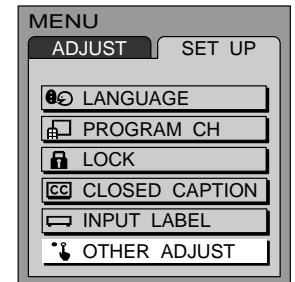

2 Press to select OTHER ADJUST.

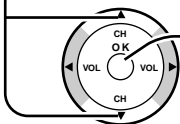

Press to access OTHER ADJUST.

3 Press to select the item that you would like to change.

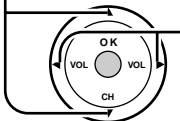

Press to select desired condition.

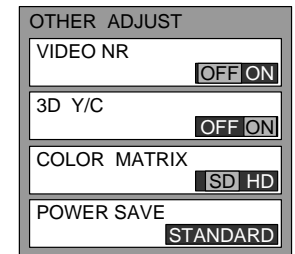

VIDEO NR

Reduce video noise in the picture.

Selection condition: **ON** ↔ **OFF**

3D Y/C FILTER

Minimizes noise and cross color in the picture.

Not available for COMPONENT VIDEO.

Selection condition: **ON** ↔ **OFF**

COLOR MATRIX

Displays input signals (480p signals) in a natural color.

Automatically adjusts color parameters for HD (high definition) and SD (standard definition).

Selection condition: **SD** ↔ **HD**

POWER SAVE

The POWER SAVE will be suitable for watching at night and power consumption will be reduced.

selection condition: **STANDARD** ↔ **SAVING**

Operating peripheral equipment using the remote control

Programming The Illuminated Remote Control Using Access Codes

The Universal Remote Control can be programmed to operate many manufacturers' components, using the component function buttons for TV, VCR, DBS/CABLE or DVD. Follow the procedures for programming your Remote Control with or without a code for the component.

Determine the manufacturer of the component and look in the table for the code.

1 Confirm that the external component is plugged in and operating.

2 Turn the component off.

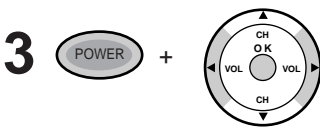

Press **POWER** and **OK** together, **for at least 5 seconds**. After 5 seconds, all the illuminated mode keys will begin to flash. Release the POWER and OK keys.



Press the mode key. The mode key will illuminate steadily, all others will go out.

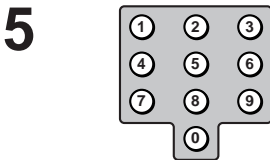

Enter the 3-digit component code using the Remote Control numeric keypad.



Press the Remote Control **POWER** to test the component. If the procedure is successful, the component will turn on.

Default Modes For Remote Control

Device	Operates	Default
TV	TV (Panasonic Only)	Panasonic TV Codes
VCR	VCR (Preset)	Panasonic VCR Codes
DBS/CBL	DBS (Preset), CABLE (Preset)	Panasonic DBS Codes
DVD	DVD (Preset)	Panasonic DVD Codes

Helpful Hints: Unsuccessful Code

If the component does not operate with the Remote Control, repeat the procedure using another code. (Some brands have multiple codes).
If an incorrect code is entered, or if the procedure takes longer than 30 seconds, the programming will fail.

Operating peripheral equipment using the remote control

Programming Without A Code (When the code is not known)

This procedure searches all codes and is called the "sequence method."

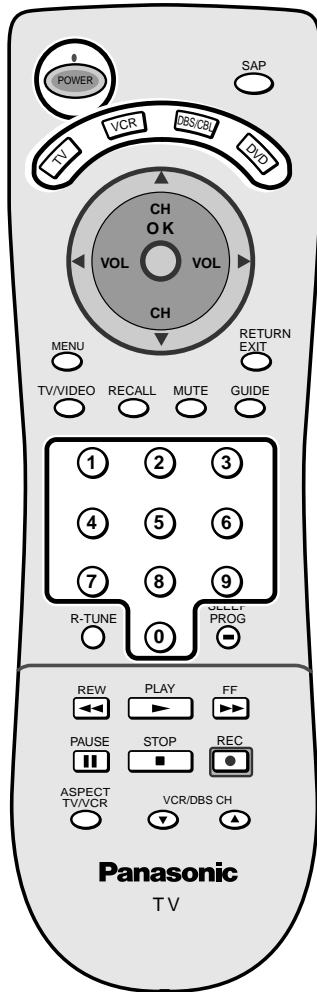

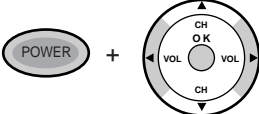

1 Confirm that the external component is plugged in and on.

2 Turn the component off.

3  Press **POWER** and **OK** together, for at least 5 seconds. After 5 seconds, all the illuminated mode keys will begin to flash. Release the **POWER** and **OK** key.

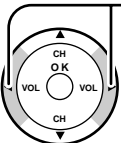
4  Press the mode key. The mode key will illuminate steadily, all others will go out.

5  Press to move forward to the next code, or to move backward.

6  Press the Remote Control  to test the component. If the procedure was successful, the component will turn on.

Note:

Repeat the above steps until the component code is found. It may take many attempts before the correct code is found.

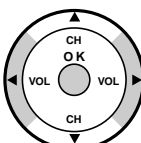
7  After the code is found, press **OK** to store the code.

Note:

The step and set mode will start from the current device (not the beginning of the list, except for the first time).

Operating peripheral equipment using the remote control

Infrared Codes Index

The remote control is capable of operating many brands of peripheral equipment. Refer to pages 31 and 32 for programming procedures.

Note: The remote control memory is limited and therefore some models may not operate. The remote control is not designed to control all features available in all models.

Note: After entering the proper infrared code, press the desired Mode Selection Button on the remote control. Refer to pages 14 and 31 - 32 for details on operating peripheral equipment using the remote control.

Infrared Remote Codes for Specific Components

Helpful Hint: Write down the code numbers for your components in the space provided below. This will serve as a handy reference whenever you need to reprogram your remote control.

CABLE	<input type="text"/>	VCR	<input type="text"/>	DBS	<input type="text"/>
_____	<input type="text"/>	_____	<input type="text"/>	_____	<input type="text"/>
Other Component		Other Component		Other Component	

Codes for VCR

VCR

Brand	Code
Admiral	335
Aiwa	332
Akai	314, 315, 316, 329
Audio Dynamic	311, 339
Bell & Howell	305, 313
Broksonic	320, 326
Canon	323, 325
Citizen	306
Craig	305, 306, 329
Curtis Mathes	324, 345
Daewoo	301, 324, 343
DBX	310, 311, 339
Dimensia	345
Emerson	303, 319, 320, 325, 326, 343
Fisher	305, 307, 308, 309, 313
Funai	320, 326, 334
GE	324, 333, 345
Goldstar	306
Gradiente	334
Hitachi	300, 323, 345
Instant Replay	323, 324
Jensen	339
JVC	310, 311, 334, 339
Kenwood	306, 310, 311, 339
LXI	300, 305, 306, 307, 308, 309
Magnavox	323, 324, 331
Marantz	310, 311, 339
Marta	306
Memorex	309, 324
MGA	338, 340, 341, 347, 348
Minolta	300, 345
Mitsubishi	338, 340, 341, 347, 348
Multitech	304, 347
NEC	310, 311, 334, 339
Olympic	323, 324
Optimus	306, 321, 328, 335

Brand	Code
Orion	320, 326
Panasonic	321, 322, 323, 324
J.C.Penney	300, 305, 310, 311, 324, 339, 345
Pentax	300, 311, 345
Philco	320, 323, 324, 326, 331, 343
Philips	323, 324, 331
Pioneer	323
Proscan	300, 301, 302, 323, 324, 331, 333, 345, 346
Quasar	321, 322, 323, 324
Radio Shack	305, 309, 324, 333, 336, 340
RCA	300, 301, 302, 323, 324, 331, 333, 345, 346
Realistic	305, 309, 324, 336, 340
Samsung	302, 304, 333
Sansui	320, 326, 339, 352
Sanyo	305, 309, 313
Scott	301, 302, 304, 309, 320, 326, 338, 340, 347, 348
Sears	300, 305, 306, 307, 308
Sharp	335, 336
Shintom	317
Signature 2000	335
Singer	317
Sony	328, 329, 330
Sylvania	323, 324, 331
Tashiro	306
Tatung	310, 311, 339
Teac	310, 311, 339
Technics	321, 322, 323, 324
Teknika	324
Toshiba	301, 346
Vector Research	311
Wards	306, 309, 335, 336, 344
Yamaha	305, 310, 311, 339
Zenith	306, 344

Codes for Personal Video Recorders

VCR

Brand	Code
Panasonic Replay	100
Philips Tivo	101
Sony Tivo	102

Operating peripheral equipment using the remote control



Codes for DVD

Brand	Code
Denon	100
Ferguson	101
JVC	109
Mitsubishi	105
Nordmende	101
Panasonic	100
Philips	103
Pioneer	102
RCA	101

Brand	Code
Saba	101
Samsung	110
Sharp	108
Sony	104
Technics	100
Thomson	101
Toshiba	103
Yamaha	100
Zenith	107



Codes for Cable Box

Brand	Code
ABC	124
Archer	125, 132
Cableview	105, 132
Citizen	105, 122
Curtis	112, 113
Diamond	124, 125, 132
Eagle	129
Eastern	134
GC Brand	105, 132
Gemini	122
General	111, 119, 120, 121, 122, 123,
Instrument/ Jerrold	124, 125, 126, 127
Hamlin	112, 118, 140, 141, 142, 145
Hitachi	103, 124
Macom	103, 104, 105
Magnavox	133
Memorex	130
Movietime	105, 132
Oak	102, 137, 139
Panasonic	109, 110, 114
Philips	106, 107, 128, 129, 130
Pioneer	101, 116
Pulsar	105, 132

Brand	Code
Puser	132
RCA	115
Realistic	132
Regal	112, 118, 140, 141, 142, 145
Regency	134
Rembrandt	105, 132, 137
Samsung	105
Scientific Atlanta	111, 112, 113
Slmark	101, 105
Sprucer	105, 110
Stargate	105, 132
Tel eview	101, 105
Texscan	144
Tocom	135
Toshiba	104
Unika	125, 132
Universal	122, 132
Videoway	106
Viewstar	129, 130
Zenith	100, 117
Zenith /Drae	100
Satellite	



Codes for DBS















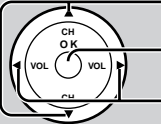

Brand	Code
Dish Network (Echostar)	105, 115, 116
Echo Star	105
Express VU	105, 115
G.E.	106
G.I. (General Instrument)	108
Gradiente	114
Hitachi	103, 111, 112
HNS (Hughes)	103

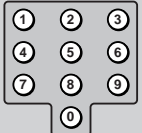
Brand	Code
Magnavox	101, 102
Panasonic	104
Philips	101, 102
Primestar	108
Proscan	106, 109, 110, 113
RCA	106, 109, 110, 113
Sony	107
Star Choice	103, 108
Toshiba	100
Uniden	101, 102

Operating peripheral equipment using the remote control

Mode Operational Key Chart

This chart defines which keys are operational after programming (if needed), while in the selected remote control mode TV, DTV, CABLE, DBS, VCR, DVD ...etc.

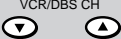
KEY NAME	TV MODE	CABLE MODE	DBS MODE	VCR MODE	DVD MODE (DVD)
	POWER	POWER	POWER	POWER	POWER
	SAP ON/OFF	–	STB AUDIO TRACK	–	–
	MUTE	TV MUTE	STB MUTE	TV MUTE	TV MUTE
	TV INPUT SW	TV INPUT SW	TV INPUT SW	TV INPUT SW	TV INPUT SW
	CHANNEL UP/DOWN	CABLE CHANNEL UP/DOWN	STB NAVIGATION UP/DOWN	TV CHANNEL UP/DOWN	NEXT/PREVIOUS CHAPTER
	ACTION	ENTER	STB ACTION	TV ACTION	NEXT/PREVIOUS CHAPTER
	VOL + / –	CABLE VOL + / –	STB NAVIGATION RIGHT/LEFT	TV VOLUME +/-	TV VOLUME +/-
	MENU	–	STB MENU	–	–
	DISPLAY	–	–	ONSCREEN VCR DISPLAY	–
	EXIT	–	STB EXIT	–	–
	–	–	STB GUIDE	–	–
	Select Channel	Select Channel	Select Channel	Select Channel	–
	PREVIOUS CHAN OR VIDEO MODE	CABLE PREVIOUS	STB PREVIOUS	–	–
	SLEEP	–	STB PROGRAM/DASH	–	–
	–	–	–	VCR REW/FF	SKIP SEARCH <<REW/>>FF
	–	–	–	PLAY	PLAY
	–	–	–	PAUSE	PAUSE
	–	–	–	STOP	STOP
	–	–	–	VCR RECORD	–
	ASPECT	–	STB ASPECT	TV/VCR SWITCH	OPEN/CLOSE
	–	–	PAGE UP/DOWN	VCR CHANNEL UP/DOWN	SLOW +/-

Manuel de instrucciones [Resumen]

Estimado cliente de Panasonic

Bienvenido a la familia de clientes de Panasonic.

Esperamos sinceramente que disfrute durante muchos años de su nuevo televisor LCD.

Para obtener el máximo beneficio de su aparato, lea estas instrucciones antes de hacer cualquier ajuste, y guárdelas para poder utilizarlas como referencia en el futuro.

Guarde también el recibo de su compra, y anote el número del modelo y el número de serie de su aparato en el espacio provisto en la cubierta posterior de estas instrucciones.

Preparación

Instalación de las pilas en el control remoto

Cambio de las pilas

Cambie las pilas siguiendo los pasos indicados más abajo:

Se necesitan dos pilas AA.

1. Abra la cubierta de las pilas.
2. Instale las pilas como se muestra en el compartimiento de las pilas. (Las polaridades + y – deben coincidir con las marcas correspondientes del compartimiento).
3. Vuelva a colocar la cubierta.

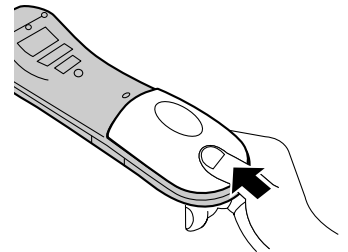
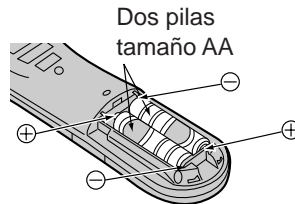
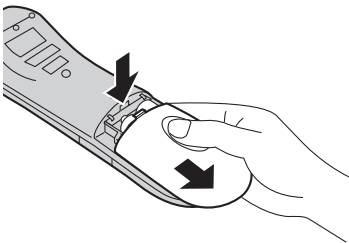

⚠ Precauciones relacionadas con la utilización de las pilas

La instalación incorrecta de las pilas puede causar fugas en las mismas que podrían estropear el transmisor de mando a distancia.

Tome las precauciones siguientes:

1. Utilice siempre pilas nuevas cuando reemplace las viejas.
2. No intente cargar, cortocircuitar, desarmar, calentar o quemar las pilas usadas.
3. Las pilas deberán cambiarse cuando el mando a distancia funcione esporádicamente o no pueda controlar esta unidad.

Conexión

Conexión del cable de antena al terminal de entrada de RF

Conexión de antena - Para recibir correctamente los canales de VHF/UHF se requiere una antena externa. Para obtener la mejor recepción se recomienda utilizar una antena para exteriores. El modo de antena debe ajustarse a TV.

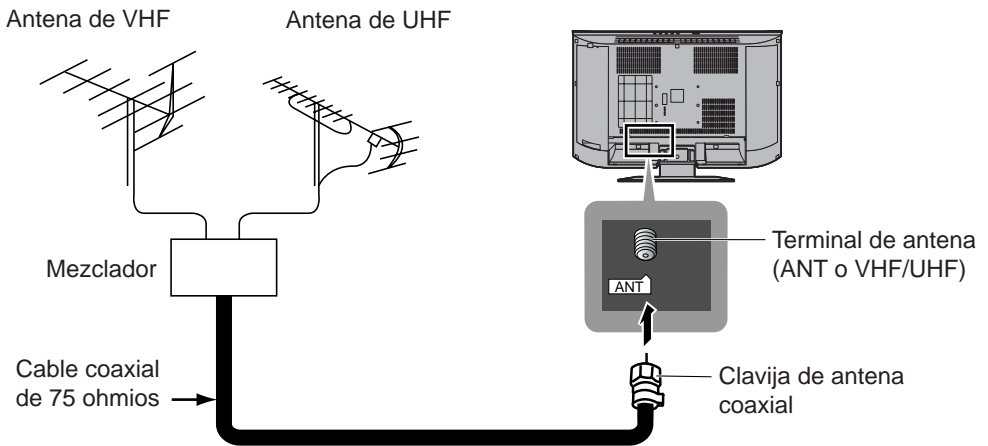

Desmontaje e instalación de la cubierta de la antena

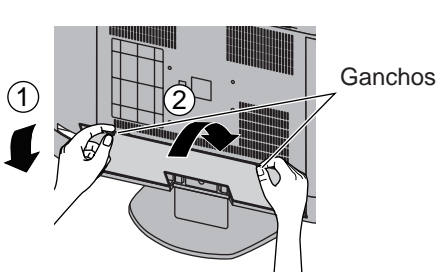

① Desmontaje

1. Empuje los ganchos hacia arriba y tire ligeramente de la cubierta hacia usted mismo para soltar las garras (en 4 puntos).
2. Saque lentamente la cubierta hacia abajo.

② Instalación

1. Inserte las garras (en 4 puntos) en el extremo de la parte superior.
2. Empuje la cubierta hasta que los ganchos hagan un ruido seco.

Nota:

Para evitar que aparezcan interferencias en la pantalla, no junte el cable de la antena y el cable del adaptador de CA.

Conexión de antena / cable

Cable entrante de 75 ohmios procedente de la antena del hogar/compañía de televisión por cable

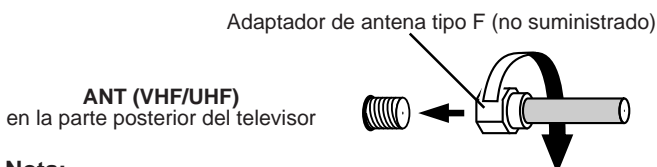

Conexión de cable - Para recibir los canales de televisión por cable (01 - 125) conecte el cable suministrado por su compañía de televisión por cable. El modo de antena debe ajustarse a CABLE. (Consulte la sección Modo de la antena.)

Nota:

Ciertos sistemas de televisión por cable neutralizan algunos canales para reducir interferencias o tienen canales especiales (codificados). Para recibir correctamente estos canales se necesita un sintonizador de conversión de televisión por cable. Póngase en contacto con su compañía de televisión por cable para conocer los requerimientos de compatibilidad.

Para quitar y colocar la cubierta del cable

Para quitarla

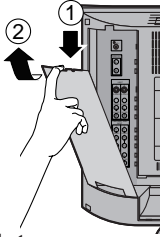

1. Suelte los ganchos del extremo más alto.
2. Sáquela lentamente hacia arriba.

Para colocarla

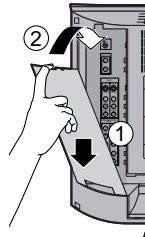

1. Inserte los ganchos (en 2 puntos) en el extremo más bajo.
2. Empújela hacia adentro en el extremo más alto.

Nota:

Dependiendo del tipo de cable utilizado, tal vez no sea posible cerrar la cubierta. En tales casos, el cable podrá instalarse a través de la cubierta de la antena.

Como conectar el término del entrada/salida

Reproducción en una videograbadora o en otro equipo periférico

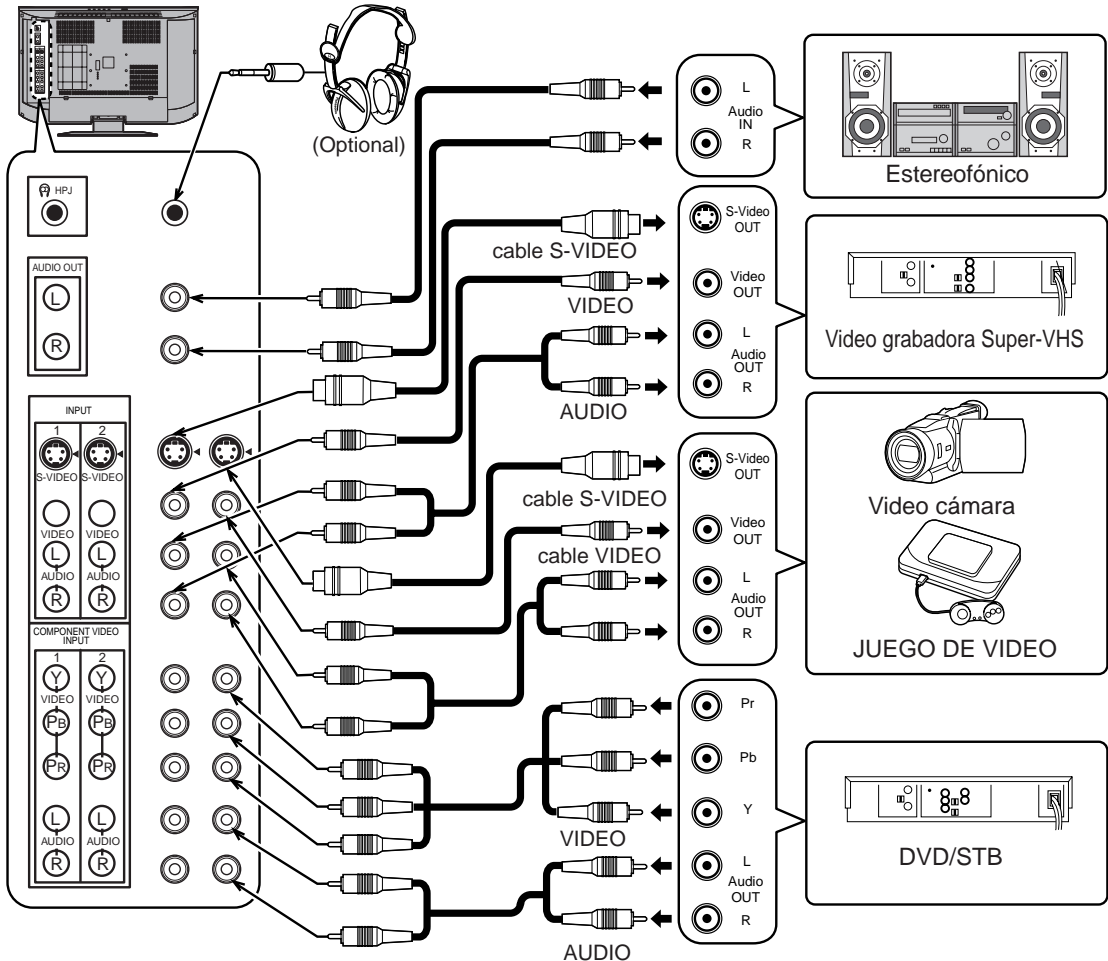

Notas:

- Cuando se conecten cables de vídeo, y cuando se encuentren hechas conexiones al mismo tiempo al terminal de entrada de S-vídeo y al terminal de entrada de vídeo, se dará prioridad al cable de S-vídeo.
- El control de salida de sonido es fijo (SONIDO, AJUSTE, VOLUMEN subir/abajo Y Ambiente conexión/desconexión son no funciona para el terminal de Audio Out).

Conexión/desconexión de la alimentación

Conexión de la clavija a la toma de corriente

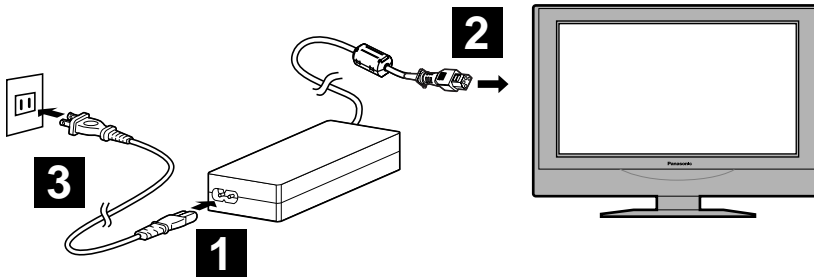

Nota:

El televisor y el adaptador de CA consumirán algo de energía siempre que el cable de alimentación esté conectado a la toma de corriente.

Cómo conectar la alimentación

Interruptor POWER principal

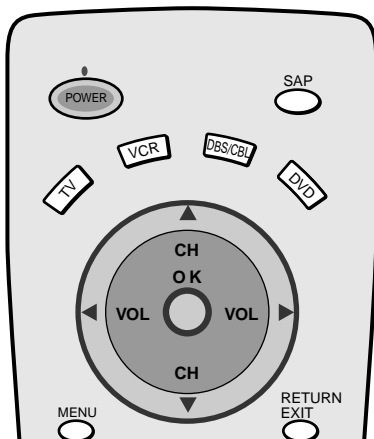
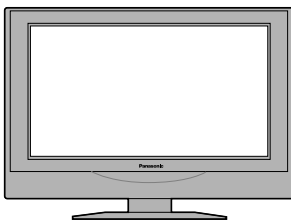
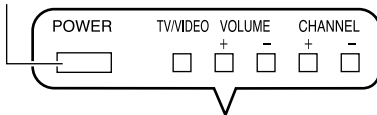

Presione el interruptor POWER principal del televisor para encenderlo.

POWER-ON: Verde

Cuando el aparato esté en el modo de alimentación conectada o en espera, pulse el interruptor POWER principal del televisor para apagarlo.

POWER OFF: Apagado

Ejemplo: La pantalla de abajo se visualiza durante un rato después de encenderse el televisor. (La condición de ajuste es un ejemplo.)



POWER — Pulse el botón POWER del mando a distancia para apagar el televisor: Rojo (espera)

Pulse el botón POWER del mando a distancia para encender el televisor: Verde

Nota:

El cable de la alimentación del televisor deberá enchufarse primero al tomacorriente, y el televisor encenderse luego con el interruptor POWER (modo de espera).

Ubicación de los controles

Control remoto iluminado

Botón de la alimentación

Púlselo para encender o apagar el televisor.

Nota: El cable de la alimentación del televisor deberá enchufarse primero al tomacorriente, y el televisor encenderse luego con el interruptor POWER (modo de espera).

Botones de selección de modo

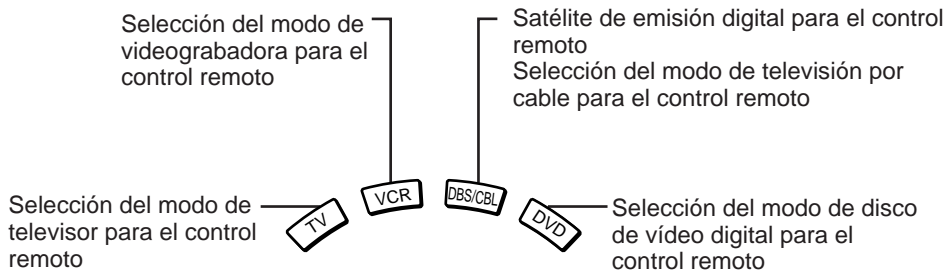

R-TUNE Botón R-TUNE



Cambia al canal o modo de vídeo anterior.

Funcionamiento de otro dispositivo

Botones	REW / FF	PLAY	PAUSE	STOP
Aparato				
Videograbadora	Rebobinado/avance rápido de videograbadora	Reproducción	Pausa	Parada
CABLE/DBS	—	—	—	—
DVD	Búsqueda con salto en rebobinado/avance rápido	Reproducción	Pausa	Parada

Botones	REC	ASPECT TV/VCR	VCR/DBS CH
Aparato			
Videograbadora	Grabación de videograbadora	Comutación de televisor/videograbadora	Subida/bajada de canal para videograbadora
CABLE/DBS	—	ASPECTO de STB	UP/DOWN de Página
DVD	—	Abertura/cierre	Lentamente/+/-

ASPECT TV/VCR Botón ASPECT



Cambia el tamaño de la pantalla (consulte la página 20).

→ JUSTIFICADO → ACERCAMIENTO → COMPLETO → NORMAL →

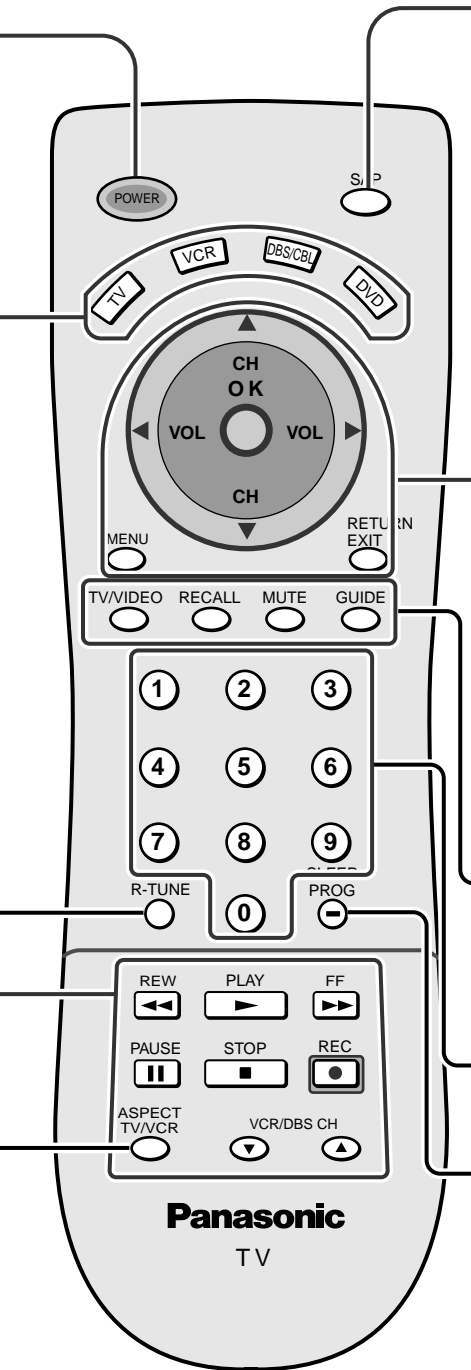

Botón SAP

Selecciona el modo de audio.

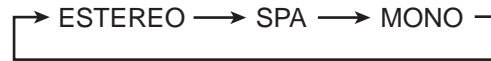

Cambia al siguiente canal superior

Mueve el cursor hacia arriba durante el modo del menú.

Reduce el volumen
Mueve el cursor hacia la izquierda durante el modo del menú.

Visualiza el menú
Presione para acceder a los menús DTV, DBS o DVD.

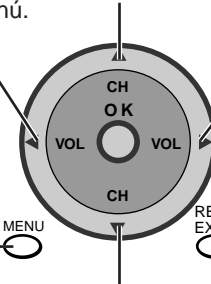

Aumenta el volumen
Mueve el cursor hacia la derecha durante el modo del menú.

Presione para volver MENU anterior o salir de MENU.

Cambia al siguiente canal inferior

Mueve el cursor hacia abajo durante el modo del menú.

El modo de entrada cambia cada vez que se presiona este botón.

Presione este botón para silenciar el sonido, y púlselo de nuevo para cancelar el silenciamiento.

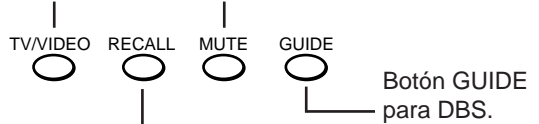

Presione para visualizar la hora, el canal, el cronometrado de apagado y otras opciones.

Botones de selección directa de números de programas



Botón PROG raya / Botón Temporizador de cancelado
Programa números de canales para DTV y DBS.

Temporizador de cancelado (Minutos)

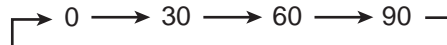

Organigrama de menús de televisión

Utilizando los botones del menú se pueden hacer todos los ajustes y configuraciones que este aparato es capaz de realizar. La pantalla de menú está compuesta de 2 menús, el menú Ajuste y el menú Configu.

1

Púlselo para visualizar la pantalla MENU, y púlselo de nuevo para cancelarla.

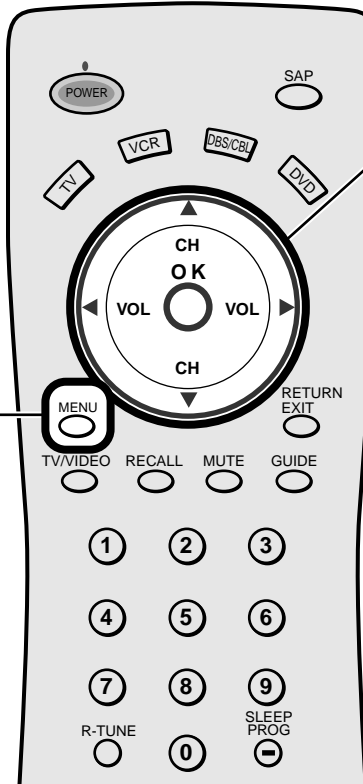

2

Selección de MENÚ

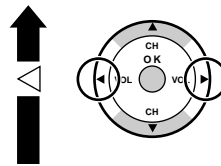
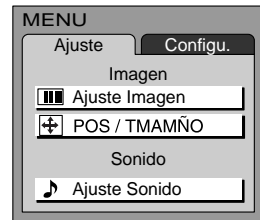

Consulte la ayuda en pantalla

El cuadro de ayuda en pantalla se visualiza siempre que aparece un menú en la pantalla. Este cuadro de ayuda indica qué teclas del mando a distancia se utilizan para desplazarse por el menú mostrado. Consulte más arriba las descripciones de las funciones de los botones.

Cuadro de instrucciones de ayuda en pantalla



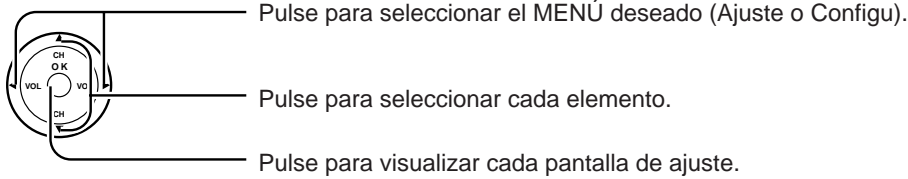

↓
Prosiga con el ajuste.

● Para volver a la pantalla anterior : Pulse para volver.

● Para finalizar el ajuste : Pulse para salir de la pantalla MENU.
Esto hace que el aparato vuelva a la condición de visión normal.

Pulse para visualizar cada pantalla de ajuste.

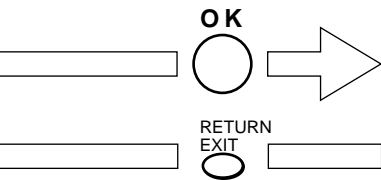

Pulse el botón RETURN para volver a la pantalla anterior.

Menú Ajuste Imagen

Ajuste Imagen	
Normalizar	
Imagen	Normal
Luz de Atras	+ 20
CONTRASTE	+ 20
BRILLO	0
COLOR	- 1
TINTE	0
NITIDEZ	0
Imagen IA	No Si

(consulte la página 21)

POS/TAMAÑO	
Normal	
Normalizar TAMAÑO	
1	
O VUELVE	

Menú Ajuste Sonido

Ajuste Sonido	
Normal	
Sonido	Dinamico
BAJOS	+ 10
ALTOS	+ 8
BALANCE	0
SON. ENVOL	No Si
ESTEREO	SPA MONO
Entr. HDMI	AUTO

(consulte la página 24)

Pulse para visualizar cada pantalla de ajuste.

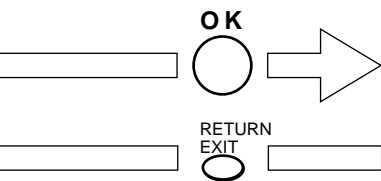

Pulse el botón RETURN para volver a la pantalla anterior.

Menú Idioma

Idioma	
Idioma	ESPAÑOL
Le permite seleccionar el idioma seleccionado en las visualizaciones en pantalla.	
ENGLISH FRANÇAIS	
ESPAÑOL	

Pantalla e ajuste Subtítulos

Subtítulos	
EN MUDO	Si
MODO	No

(consulte la página 28)

Menú Prog. Canales

Prog. Canales	
MODO	TV CABLE
PROGRAMA AUTO	
PROGRAMA MANUAL	

(consulte la página 18,19)

Menú Otro Ajuste

Otro Ajuste	
REDUC DE RUIDO	No Si
Filtro 3D	No Si
Matriz Color	SD HD
ECON ENERGÍA	ESTANDAR

(consulte la página 30)

Pantalla de selección Bloqueo

Bloqueo	
Programas	
Películas de EEUU	
Activado	No Si
Modificar	
INGRESAR CLAVE	

(consulte la página 25)

Menú Ponga Títulos

Ponga Titulos	
Componente1	Componente1
Componente2	Componente2
Video1	Video1
Video2	Video2
HDMI	HDMI

(consulte la página 30)

Sintonización de canales (Programación automática de canales)

Explora automáticamente todos los canales de TV y los almacena en la memoria.

1 Conecte la alimentación y pulse el botón TV/VIDEO para visualizar el canal de televisión.

2 Pulse el botón MENU para visualizar la pantalla MENU y seleccione Configu.

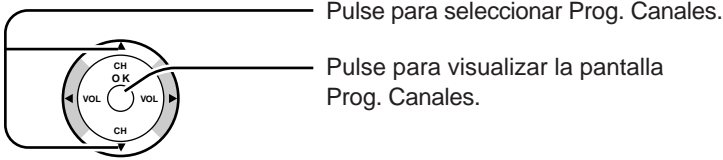

3 Pulse para seleccionar MODO.

Pulse para seleccionar TV o CABLE.

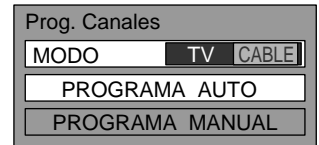
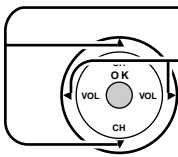

4 Pulse para seleccionar PROGRAMA AUTO.

Pulse para visualizar la pantalla de confirmación.

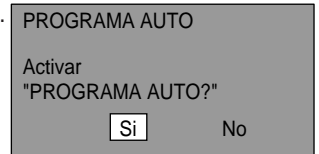
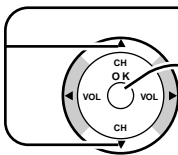

5 Pulse para seleccionar Si.

Pulse para seleccionar No.

Pulse para ejecutar PROGRAMA AUTO.

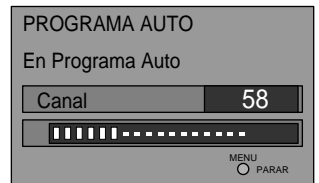
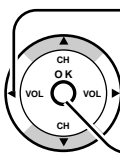

Los canales avanzarán automáticamente hasta que todos hayan sido explorados. Los números de canales con una videoseñal se almacenarán en la memoria de exploración de canales.



Pulse para salir de la pantalla MENU. Esto hace que el aparato vuelva a la condición de visión normal.

Notas:

- Cuando se pulsen botones mientras se ejecute PROGRAMAAUTO, el televisor volverá al modo de visión normal. (Los canales encontrados hasta este punto se añadirán.)
- Después de terminar PROGRAMA AUTO, se recibirá el canal con el número más bajo que haya sido añadido.
- Cuando no haya canales que puedan ser recibidos se visualizará el canal 69 (canal 125 para la televisión por cable).

Sintonización de canales (Programación manual de canales)

Utilice este ajuste cuando cambie ajustes de los canales de recepción o cuando cambie la visualización de los canales.

Encienda el televisor y seleccione el canal de emisión. Siga los pasos de la página anterior para visualizar la pantalla Prog. Canales.

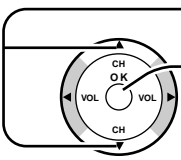
- 1**
- 
- Pulse para seleccionar PROGRAMA MANUAL.
- Pulse para visualizar la pantalla PROGRAMA MANUAL.

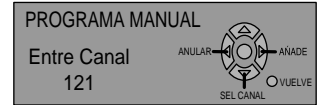
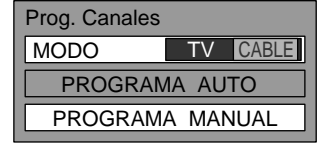

Adición o borrado de canales

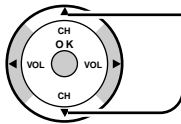
- 2**
- 
- Pulse para seleccionar canal (o teclas de números).

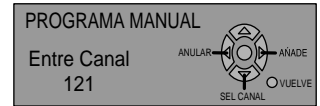

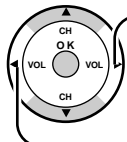
- 3**
- 
- Pulse para añadir canales a la memoria (el número del canal se pone de color azul).
- Pulse para borrar canales de la memoria (el número del canal se pone de color amarillo).

- 4** Repita los pasos 2 y 3 para continuar añadiendo o borrando canales.

- MENU**
- 
- Pulse para salir de la pantalla MENU. Esto hace que el aparato vuelva a la condición de visión normal.

Troubleshooting

Before requesting service for this LCD TV, check the chart below for a possible cause of the problem you are experiencing. Some simple checks or a minor adjustment on your part may eliminate the problem and restore proper operation. If you are in doubt about some of the check points, or if the remedies indicated in the chart do not solve the problem, consult your dealer for instructions.

Symptom		Cause and remedy	page
Power supply does not go on		<ul style="list-style-type: none"> • Is power supply plug unplugged from the outlet? • If power will not go on with the remote control, is the power supply of the TV "Off"? 	– 12
Remote control cannot be operated		<ul style="list-style-type: none"> • Is battery exhausted, or is battery polarity wrong? • Is the remote control receiver illuminated with strong light from a fluorescent lamp etc.? • Are you using the special-purpose remote control for this equipment? (The unit will not operate with another remote control.) 	7 – –
Image shakes, or image is unclear		<ul style="list-style-type: none"> • Is there deterioration, breakage or disconnection of the antenna or antenna wire? • Is the antenna wire connected correctly? 	– 8, 9
There are spots on the picture, or the screen shakes		<ul style="list-style-type: none"> • Is the system affected (by radio wave interference or induced electromagnetic waves) by external sources (automobiles or trains, high-voltage wires, neon, motors, magnetized steel frame, or iron rain shutters, etc.)? ▣ Turn off the power supply, and try changing the equipment setup location. If that has no effect, separate magnet-proofing will be required. 	–
The image appears doubled or tripled		<ul style="list-style-type: none"> • Is the antenna direction shifted? • Are reflected electromagnetic waves being received from mountains or buildings? 	–
A color pattern appears, or colors disappear		<ul style="list-style-type: none"> • Is the equipment being affected by another TV (electromagnetic interference)? ▣ Changing the TV setup location may lead to improvement. 	–
The channel number disappears from the screen		<ul style="list-style-type: none"> • Has the RECALL button been pressed? ▣ Press the "RECALL button" again. If the system is switched to external input and there is no external signal video, the number will disappear. 	–
When the image is not stable, the screen turns completely white for a moment		<ul style="list-style-type: none"> • This occurs when the signal driving the liquid crystal is lost, and is not a malfunction. 	15
The screen goes dark momentarily when the channel is changed.		<ul style="list-style-type: none"> • The screen is darkened for a moment to conceal noise generated when changing channels. 	–
The TV makes a hissing noise occasionally		<ul style="list-style-type: none"> • If the screen and audio are not abnormal, this sound is caused by slight expansion and contraction of the cabinet due to changes in room temperature. It has no effect on performance. 	–
The screen display shakes with video input		<ul style="list-style-type: none"> • When input is switched to "video input", this may occur if there is no signal at the video/audio input terminal. 	–
A black band appears momentarily when selecting channels with video		<ul style="list-style-type: none"> • This is due to noise generated when changing channels. 	10, 11 –
Both edges of the screen, or columns or window frames, appear bent		<ul style="list-style-type: none"> • They may appear bent due to the received channel or some DVD software. This is not a malfunction. 	–
The image from the connected equipment does not appear		<ul style="list-style-type: none"> • Are plugs securely inserted into each terminal? ▣ Securely insert plugs all the way. 	10, 11
The main unit is hot to the touch		<ul style="list-style-type: none"> • The main unit radiates heat, so some parts of the console reach a high temperature. This is not a problem for performance or quality. • Set up at a location with good ventilation. Do not cover the ventilation holes of the console with a tablecloth, etc., and do not place on top of other equipment (like a video deck). 	–
H D M I	Poor Video (Example: Snow noise, no picture, picture runs, etc.)	<ul style="list-style-type: none"> • Check HDMI cable is connected securely. • Turn the power supply of the TV set and connected equipment ON/OFF. • Check compatibility of connected signal. Change settings of connected equipment to make signal compatible. • Is the input source from the equipment that is EIA/CEA-861/861B compliant consumer electric device? 	12
	Poor Audio	<ul style="list-style-type: none"> • Set audio of connected equipment to L.PCM. • Check setting of HDMI INPUT under AUDIO ADJUST. • If the problem with the digital audio connection persists, change to an analog audio connection. 	24

Specifications

Power Source	AC 120 V, 60 Hz
Power Consumption	Average use : 92W Stand-by condition : 1.3 W TV set DC 15 V, 1.6 A max.
LCD	559 mm (22-inch), 16 : 9 aspect ratio LCD panel
Screen Size	487.7 mm (19.20 ") (W) × 274.3 mm (10.80 ") × 559.5 mm (22.03 ") (DIAGONAL)
Channel Capability	VHF-12 : UHF-56 : Cable-125
Sound	
Speakers	3W + 3W + 5W (10 % THD)
Full-range	ϕ 4 cm, 2 pcs
Woofers	ϕ 5 cm, 2 pcs
Headphones	M3 (3.5 mm) Jack × 1
FEATURES	CLOSED CAPTION V-Chip
Operating Conditions	Temperature : 41 °F - 95 °F (5 °C – 35 °C) Humidity : 5 % - 90 % RH (non-condensing)
Connection Terminals	
INPUT	VIDEO (RCA PIN Type × 1) × 2 1.0 Vp-p (75 Ω)
	S-VIDEO (MINI DIN 4pin × 1) × 2 Y : 1 Vp-p (75 Ω), C : 0.286 Vp-p (75 Ω)
	AUDIO L-R (RCA PIN Type × 2) × 2 0.5 Vrms
COMPONENT VIDEO INPUT	Y × 2 1.0 Vp-p (including synchronization)
	P _B / P _R × 2 ±0.35 Vp-p
	AUDIO L-R (RCA PIN Type × 2) × 2 0.5 Vrms
OUTPUT	AUDIO L-R (RCA PIN Type × 2) × 1 0.5 Vrms
HDMI	AUDIO L-R (RCA PIN Type × 2) × 1 HDMI TYPE A Connector × 1
Dimensions (W × H × D)	
Including TV Stand	586 mm (23.07") × 427.5 mm (16.83 ") × 255 mm (10.04 ")
TV Set Only	586 mm (23.07 ") × 387.2 mm (15.25 ") × 91.3 (3.59 ") mm)
Mass (Weight)	9.5 kg (20.9 lb.) NET

Note:

Design and Specifications are subject to change without notice. Weight and Dimensions shown are approximate.

Customer' Record

The model number and serial number of this product can be found on its rear panel. You should note this serial number in the space provided below and retain this book, plus your purchase receipt, as a permanent record of your purchase to aid in identification in the event of theft or loss, and for Warranty Service purposes.

Model Number _____

Serial Number _____

Panasonic Consumer Electronics Company, Division of Matsushita Electric Corporation of America
One Panasonic Way Secaucus
New Jersey 07094

Panasonic Sales Company, Division of Matsushita Electric of Puerto Rico Inc. ("PSC")
Ave. 65 de Infanteria, Km 9.5
San Gabriel Industrial Park,
Carolina, Puerto Rico 00985

Panasonic Canada Inc.
5770 Ambler Drive
Mississauga, Ontario
L4W 2T3